

# P12

**640 W LED POWER**

**P12 SPOT**

+ Animation  
module

**P12 PROFILE**

+ Framing  
module



**Zoom**  
5.7° - 60°  
(1:10.5)

**Output**  
25,000  
lumen

**only**  
29 dB(A)  
extremely  
quiet

**only**  
23 kg  
weight

**640 W**  
white light  
LED

**Made in**  
GERMANY

**The quick-change artist**  
with the full range of effects and  
innovative modular technology



## The P12 is fascinating: extremely bright, modular and incredibly effective!

The P12, with 640 Watt LED power, is incredibly bright, extremely light and compact with a weight of only 23 kg. Thanks to its modular design, it can also be used flexibly and can be used as a spot or profile version.

With its features, the P12 leaves nothing to be desired. Thanks to a zoom range of 5.7°–60° (1:10.5), its precise optics and enormous versatility, it meets all the requirements of modern lighting design. With its full range of effects including color wheel, two gobo wheels with 12 rotating gobos, CMY color mixing unit, linear CTO and two frost filters and prisms, it transforms any event into a light spectacle. The extremely quiet P12 is at home in the brightness class of comparable moving lights with 1,200 watts and masters every task with flying colors – and that with a power consumption of just 800 watts.

**The P12 is a versatile quick-change artist for show and theatre stages, opera houses, trade fairs and TV, with features such as:**

- Zoom from 5.7°–60° (1:10.5)
- CMY color mixing unit and linear CTO
- 2 gobo wheels with 6 rotating gobos each
- 1 color wheel with 7 colors + High CRI filter
- Electronic shutter with pre-programmed pulse and ramp functions
- 2 prisms (3-section circular or 5-section linear)
- 2 stepless, variable frost filters (soft edge, flood frost)
- Infinitely adjustable high-speed iris
- Graphic color-touch display, rotated electronically
- Ultra-quiet 29 dB(A)
- Flicker-free operation, camera mode 100 Hz–3 kHz
- 4 carrying handles for easy handling



### P12

HP (High Power)

6800 K

46,000 lm (25,000 lm Output)

CRI > 70

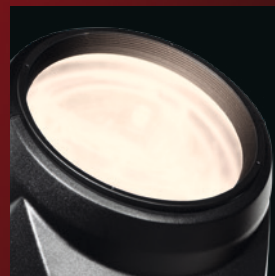

### P12

HC (High CRI)

5800 K

34,000 lm (19,000 lm Output)

CRI > 90



DMX



Ethernet



Wifi



Bluetooth

Find more information at: [www.jb-lighting.de](http://www.jb-lighting.de)



**7**  
brilliant  
colors

**12**  
rotating  
gobos

**CMY**  
+ variable  
CTO

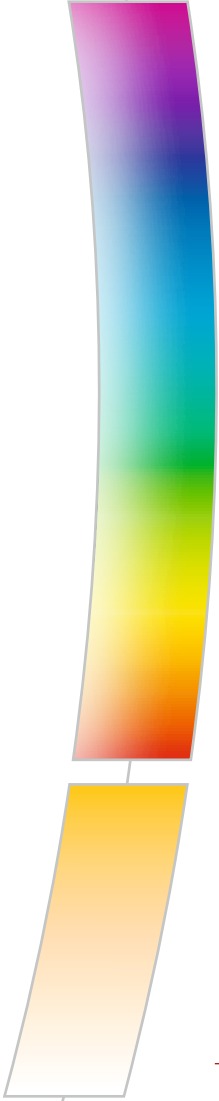
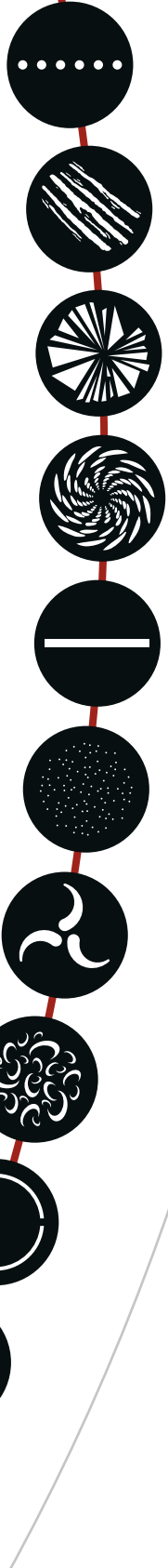
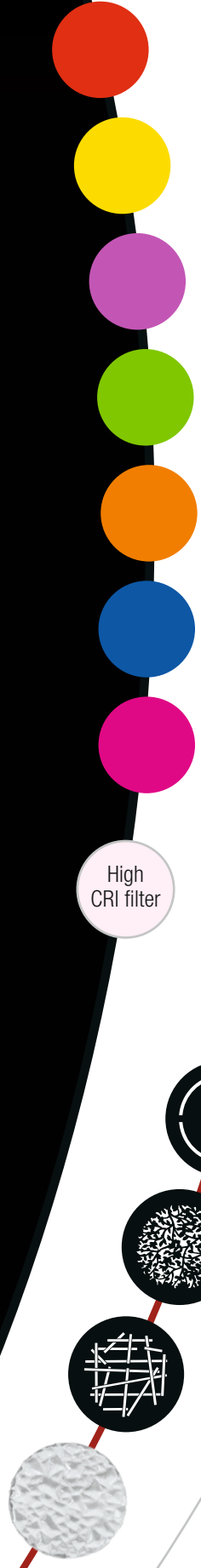

**PHOTOMETRIC DATA**

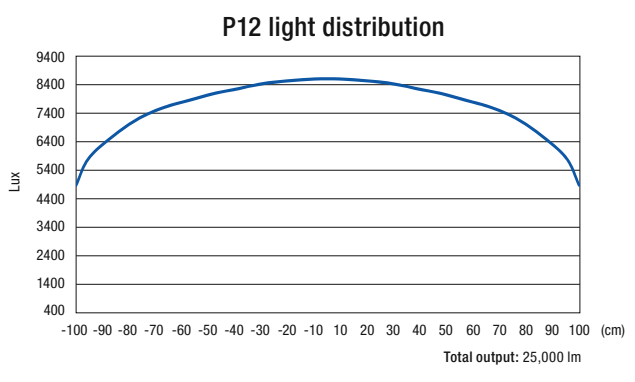
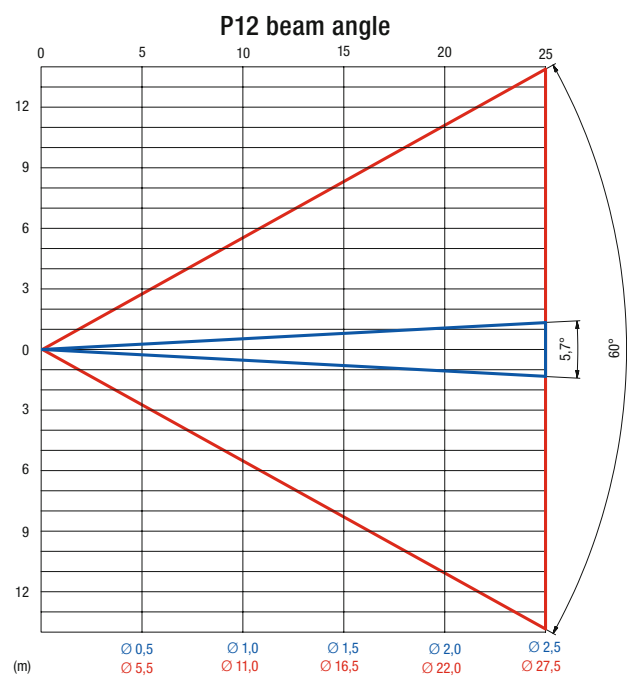

**PRISMS & FROST FILTERS**

The gobos of the P12 can be combined with two rotating prisms to create impressive effects. In addition, the P12 has two infinitely variable frost filters, making it ideal for all applications.

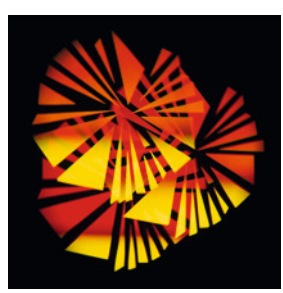

3-section prism (circular)

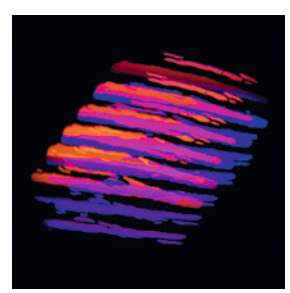

5-section prism (linear)



Frost: soft edge | flood frost

**JB SLIDE-IN TECHNOLOGY**

Cleaning, gobo and module changes can be done in no time at all with the P12. All plug-ins can be removed without tools or manual cable disconnection.



7  
brilliant  
colors

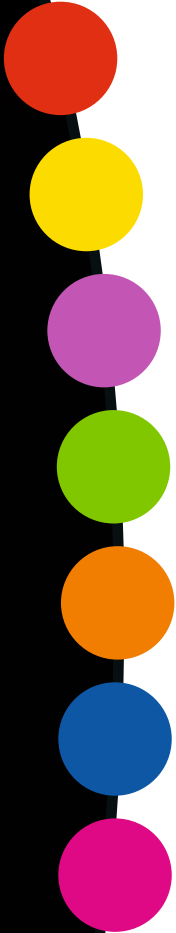

High  
CRI filter

12  
rotating  
gobos

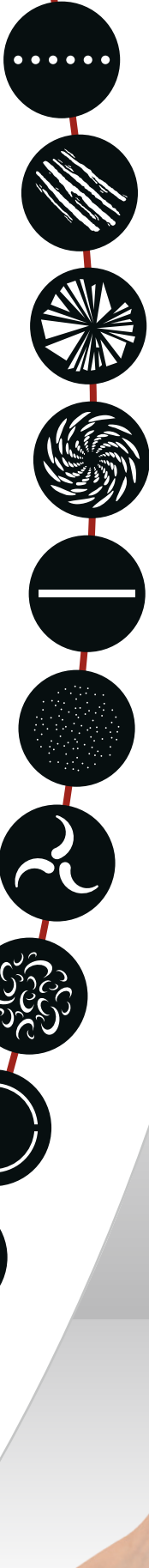

CMY  
+ variable  
CTO

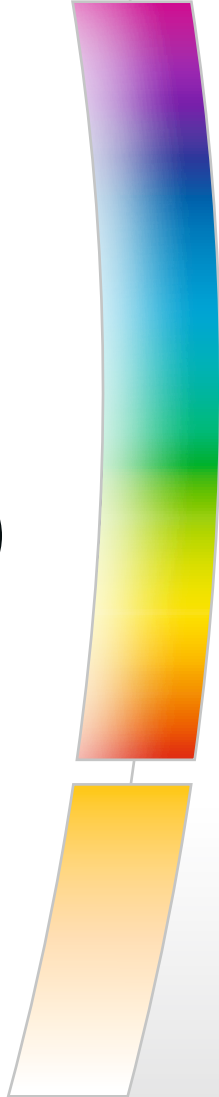

# P12

---

## SPOT

### P12 SPOT: ANIMATION MODULE

The P12 Spot is also equipped with a fully-fledged, endlessly rotating animation wheel. This will give fans of realistic fire and water effects their money's worth. With the P12 Spot, the versatile all-rounder from JB, lighting, design becomes an endless pleasure.





# P12

---

## PROFILE

### P12 PROFILE: FRAMING MODULE

The P12 Profile is equipped with a framing module capable of rotating  $\pm 55^\circ$ . Each blade can be independently adjusted in position and angle and shuts completely. This allows fast and precise geometric shapes to be created for targeted illumination or shading of objects and scenarios.

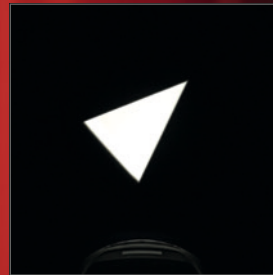

Individually controllable blades with variable angle and position



The framing module is rotatable by  $110^\circ$



A „total curtain“ effect made separately by each of the 4 blades, also exact parallel position possible

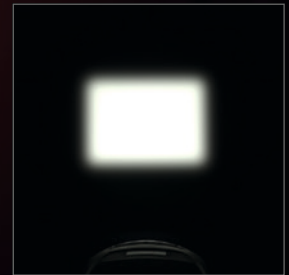

Frost filters create soft, perfectly homogeneous edges

### THE 2in1 PRINCIPLE

The P12 is designed so that it is easy to convert a spot into a profile and vice versa. Simply equip the P12 with either an animation or framing module and you're done!

## Technical specifications:

### Optics and light source

- 640 W white light LED module  
HP (High Power): 6800 K; 46,000 lm (25,000 lm Output); CRI > 70  
HC (High CRI): 5800 K; 34,000 lm (19,000 lm Output); CRI > 90
- > 20,000 h life time
- Flicker-free operation, camera mode 100, 120, 600 Hz und 3 kHz
- Zoom range: 5.7° – 60° (1:10.5)

### Effects

- 2 gobo wheels, each with 6 rotate-, position- and interchangeable gobos + open
- CMY color mixing unit for fast and homogeneous color mixing + linear CTO
- 1 color wheel with 7 full and semi colors + open also linear color selection, color filters interchangeable
- High CRI filter
- 2 frost filters (soft edge/flood frost), continuously variable – optional further frost stages possible
- 2 prisms, linear and circular, rotate- and indexable
- Motorised infinitely adjustable high-speed iris
- Electronic dimmer 0% – 100%
- Electronic shutter with preprogrammed puls- and ramp functions
- Animation effect / Sparkle effect
- Focus system with auto focus function

### Equipment of the P12 Profile:

- Framing module with 4 blades – each fully closing (total curtain) and with separate motion and rotation control, module can be rotated by 110°

### Equipment of the P12 Spot:

- Animation module with endlessly rotating animation wheel

### Movement

- 3 phase extra strong stepping motors
- Precise, very fast and silent movement
- 540° pan / 280° tilt

### Control and programming

- USITT DMX-512, RDM
- Ethernet interface with Art-Net, sACN and Kling-Net
- Wireless DMX / RDM Lumen Radio CRMX TIMO
- Bluetooth, Wifi
- Color touch display with function keys and battery backup
- Mini USB for software update
- Stand-alone mode, master/slave function
- Built-in DMX analyser

### Construction

- Original JB-Lighting slide-in module technology
- Rugged construction with carrying handles
- Transport lock for pan/tilt
- Fan control for almost noiseless operation, 29 dB(A)
- Graphical display, electronically revolvable
- Neutrik 5pin XLR IN/OUT
- Neutrik powerCON TRUE1 IN/OUT

### Rigging

- 2 Omega brackets for quick and convenient installation

### Electrical specification

- Max. power consumption 800 VA
- Input voltage range 100V–240V, 50/60 Hz

### Mechanical specifications

- Dimensions: W 421 x D 264 x H 682 mm
- Weight: 23 kg

### Scope of delivery

- Schuko on powerCON TRUE1, flexible rubber cable (2m long, 3x1.5 mm<sup>2</sup>)
- 2 Omega brackets

## Dimensions:

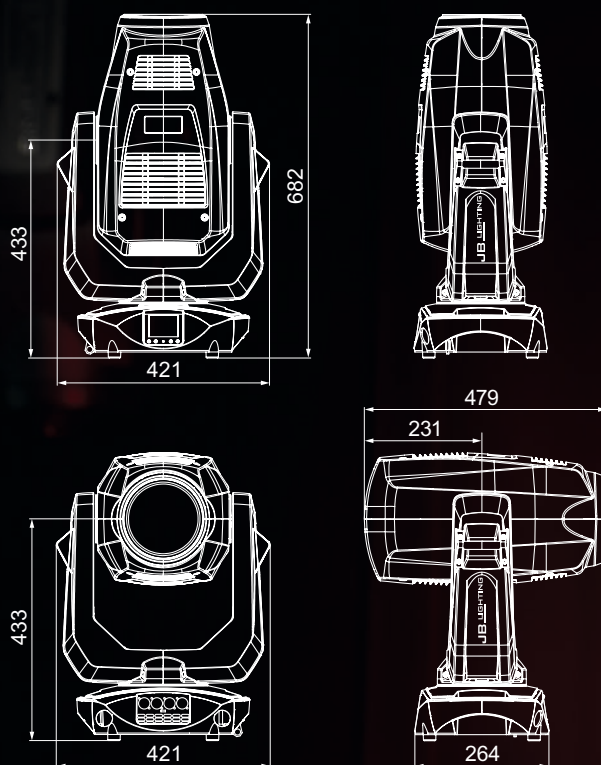

### + Accessories – flight cases:

- **Lens hood** (Code JBK0322)
- **AMPTOWN double** with SIP foam inlet (Code CASE38)  
– Dimensions: W 60 x D 60 x H 90 cm  
– Weight without (incl. fixtures): approx. 48 (94) kg
- **AMPTOWN fourfold** with SIP foam inlet (Code CASE39)  
– Dimensions: W 120 x D 60 x H 90 cm  
– Weight without (incl. fixtures): approx. 76 (168) kg



# JB LIGHTING

JB-Lighting Lichtenlagentechnik GmbH  
Sallersteig 15 · D-89134 Blaustein · Tel. +49 (0)7304 9617-0  
E-Mail: info@jb-lighting.de · [www.jb-lighting.de](http://www.jb-lighting.de)