



fos/4 Fresnel User Manual

Version 1.3.0

Part Number: 7470M1200-1.3.0 Rev: B

Released: 2023-11

To view a list of ETC trademarks and patents, go to etconnect.com/ip. All other trademarks, both marked and not marked, are the property of their respective owners.

For a complete list of all third-party licenses that are fully incorporated herein to the extent required by each third-party license terms and conditions, please visit etconnect.com/licenses.

ETC intends this document, whether printed or electronic, to be provided in its entirety.

Table of Contents

Introduction	1
Help from ETC Technical Services	2
Safety	3
Overview	5
Fixture	5
User Interface	6
Display	7
What's Controlling the Fixture?	7
Set Up and Focus the Fixture	8
Mount the Fixture	8
Add Accessories	8
Connect Power and Data	9
Focus the Fixture	10
Use Fixture in DMX Mode	11
Set DMX Address	12
Set DMX Mode	12
DMX Modes	12
Set DMX Loss Behavior	17
Use Fixture in Stand-alone Mode	18
Studio Mode	19
Color Mode	20
Gel Mode	21
Effects Mode	22

Preset Mode	23
Use Wireless Control	24
Set Up Multiverse Wireless Communication	24
Configure Fixtures Using the Set Light App	24
Control and Customize the Display	25
Lock the Display	25
Adjust the Display Settings	25
Troubleshooting and Maintenance	26
Troubleshooting Checklist	26
Adjust the Pulse Width Modulation (PWM)	27
Test the Emitters	27
View Diagnostic Data	28
View Battery Level	28
Export Fixture Data for Troubleshooting	29
Restore Default Settings	30
Update Firmware	30
Backup and Restore the Fixture Configuration	31
Clean the Lens	31
Specifications and Reference	32
Environment	32
Dimensions and Weight	32
Electrical	32
RDM Parameters	33
Fixture Compliance	34
Licensed Software	35

Introduction

The fos/4 Fresnel is a shapable wash light with top quality, highly tunable output. The fos/4 Fresnel is available in two sizes, and each size is available in two array types:

- **Lustr X8:** The next generation of the Lustr color system incorporates deep red into the already amazing x7 mix to create an even more rich, vibrant X8 color palette.
- **Daylight HDR:** Years of research resulted in an LED mix that yields the highest quality tunable white light, optimized for studio use.

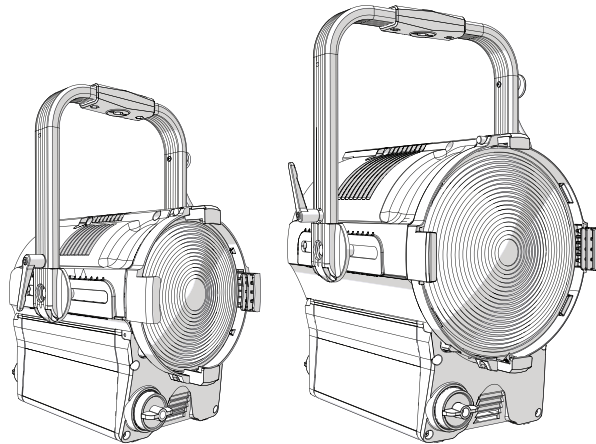

Medium
(FL7 or FD7)

Large
(FL10 or FD10)

Model	Array Type	Aperture Size	Weight
fos4FL7	Lustr X8	7 in (17.8 cm)	11.1 kg (24.5 lb)
fos4FD7	Daylight HDR		
fos4FL10	Lustr X8	10 in (25.4 cm)	13.4 kg (29.5 lb)
fos4FD10	Daylight HDR		

Images in this document show the Medium (FL7 or FD7) fixture unless otherwise noted.

Help from ETC Technical Services

If you are having difficulties and your problem is not addressed by this document, try the ETC support website at support.etconnect.com or the main ETC website at etconnect.com. If none of these resources are sufficient, contact ETC Technical Services directly at one of the offices identified below. Emergency service is available from all ETC offices outside of normal business hours.

When calling for help, take these steps first:

- Prepare a detailed description of the problem
- Go near the equipment for troubleshooting
- Find your notification number if you have called in previously

ETC, Inc.

Americas

Technical Services Department
3031 Pleasant View Road
Middleton, WI 53562
800-775-4382 (USA, toll-free)
+1-608 831-4116
service@etconnect.com

ETC GmbH

*Germany, Austria, Switzerland,
Eastern Europe, and Russia*

Technical Services Department
Ohmstrasse 3
83607 Holzkirchen, Germany
+49 (80 24) 47 00-0
techserv-germany@etconnect.com

ETC Austin

High End Systems Products

Technical Services Department
2105 Gracy Farms Lane
Austin, TX 78758 USA
800-890-8989 (USA, toll-free)
+1-512 836-2242
hesservice@etconnect.com

ETC France

France

Zone Urbaparc -
Bâtiment E
6 Boulevard de la Libération
Saint-Denis, 93200
+33 1 4243 3535
techservfrance@etconnect.com

ETC Ltd

Europe, Middle East, and Africa

Technical Services Department
26-28 Victoria Industrial Estate
Victoria Road,
London W3 6UU England
+44 (0)20 8896 1000
techservltd@etconnect.com

ETC Asia

Asia

Technical Services Department
Room 1801, 18/F
Tower 1, Phase 1 Enterprise Square
9 Sheung Yuet Road
Kowloon Bay, Kowloon, Hong Kong
+852 2799 1220
techserv-asia@etconnect.com

Safety



WARNING: RISK OF ELECTRIC SHOCK! The light source in this luminaire is not user-replaceable, and must be replaced only by a qualified technician. Contact ETC Customer Support for assistance.

AVERTISSEMENT : RISQUE DE DÉCHARGE ÉLECTRIQUE! La source lumineuse de ce projecteur n'est pas remplaçable par l'utilisateur et ne doit être remplacée seulement par un technicien qualifié. Contactez le service client ETC pour obtenir de l'assistance.



WARNING: Note the following safety warnings before use:



- Use the fixture in dry locations only, where humidity does not exceed 90 percent (non-condensing).
 - Connect the fixture to a non-dimmable power source in order to avoid damage to the fixture's internal power supply and other electrical components. Using a dimmable power source can damage the fixture and will void the warranty.
 - Disconnect the fixture from power and DMX and allow it to cool before installing accessories or performing any cleaning and maintenance.
 - Only use mounting hardware that is rated for the total weight of the fixture and accessories.
 - When the fixture is mounted, the axis between the yoke attachment points must be parallel to the ground. Mounting the fixture in a non-parallel orientation risks property damage or bodily injury.
 - In addition to primary suspension, attach a safety cable (or other approved safety device) to the fixture. Safety cables must be rated to support ten times the fixture weight. Consult local standards to ensure that safety cables meet all requirements. See [Mount the Fixture on page 8](#).
 - Check that the accessory holder is locked and that any accessory safety cables are connected before mounting the fixture.
 - Do not operate the fixture without the lens installed.
 - Do not use this fixture with a damaged power lead. If the power lead (cord set) is damaged, it must be replaced.
 - Do not use this fixture if the lens is deeply scratched or cracked. You must replace the lens when it is damaged.
-



AVERTISSEMENT : Prendre connaissance des avertissements de sécurité suivants avant toute utilisation :

- **Débranchez le projecteur de son alimentation et du DMX et laissez-le refroidir avant d'installer des accessoires ou d'effectuer un nettoyage ou un entretien.**
- **N'utilisez que de la quincaillerie de montage adaptée au poids total des projecteurs et des accessoires.**
- **Lorsque le luminaire est accroché, l'axe entre les points de fixation de la lyre doit être parallèle au sol. Le montage du luminaire dans une orientation non parallèle risque de causer des dommages matériels ou corporels.**
- **En plus de la suspension principale, fixez une chaîne de sécurité (ou tout autre dispositif de sécurité homologué) au projecteur. Les chaînes de sécurité doivent être en mesure de supporter dix fois le poids du projecteur. Consultez les normes locales pour vous assurer que les câbles de sécurité respectent toutes les exigences.**
- **Vérifiez que le porte-accessoires est verrouillé et que les élingues de tous les accessoires sont bien attachées avant de monter le projecteur.**
- **N'utilisez pas le projecteur sans que la lentille soit installée.**
- **Ne pas utiliser ce projecteur avec un cordon d'alimentation endommagé. Si le cordon d'alimentation (câble) est abîmé, il doit être remplacé.**
- **N'utilisez pas ce projecteur si la lentille présente des rayures ou des fissures profondes. Il faut remplacer la lentille si elle est abîmée.**

The following symbols may appear on product labeling.

	The luminaire must be installed at least 0.1 m (4.0 in) away from all lighted objects. (FL7/FD7)	Le luminaire doit être installé à au moins 0,1 m (4,0 po) de tout objet éclairé. (FL7/FD7)
	The luminaire must be installed at least 0.55 m (21.7 in) away from all lighted objects. (FL10/FD10)	Le luminaire doit être installé à au moins 0,55 m (21,7 po) de tout objet éclairé. (FL10/FD10)
	This product should not be discarded as unsorted waste but must be sent to separate collection facilities for recovery and recycling.	Ce produit ne doit pas être jeté avec les déchets ménagers mais doit être déposé dans une collecte de déchets électroniques ou dans un point de collecte.

Overview

Fixture

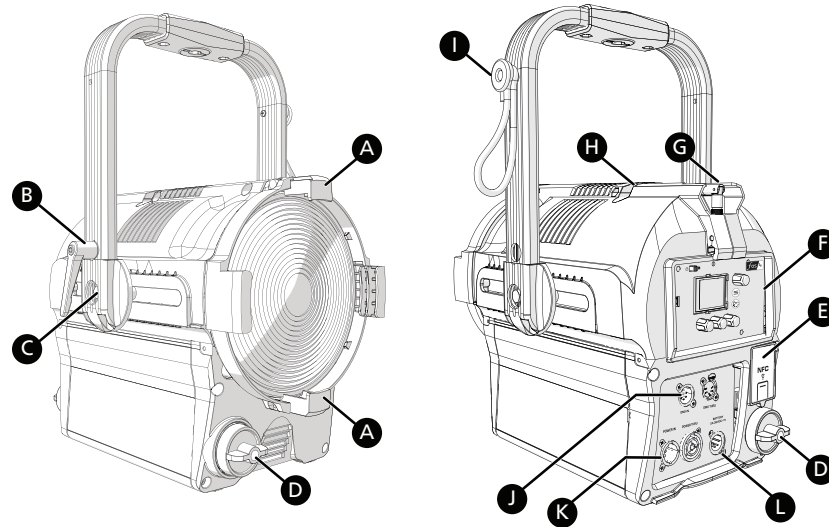

A	Accessory holder: Insert accessories into the two available slots from either side of the holder, and then lock the holder. See Add Accessories on page 8 .
B	Yoke tilt-lock: Tilt the fixture as needed, and then turn the tilt-lock clockwise to lock the position. If necessary, pull the tilt-lock away from the stem to adjust the tilt-lock position.
C	Adjustable yoke: Loosen the bolts, and then shift the adjustable yoke forward or backward as needed to balance the fixture. Tighten the bolts to secure. See Add Accessories on page 8 .
D	Zoom knob: Rotate the zoom knob on either side of the fixture to adjust from spot to flood.
E	NFC (Near Field Communication) tag: Use the Set Light app to wirelessly configure the fixture, with or without power applied to the fixture. See Configure Fixtures Using the Set Light App on page 24 .
F	User interface: View the fixture status, set the DMX address and mode, or set stand-alone options.
G	Antenna: For use when controlling the fixture using wireless DMX. See Set Up Multiverse Wireless Communication on page 24 .
H	Safety cable attachment point: See Mount the Fixture on page 8 .
I	Cable tie: Store power cable on the yoke.
J	DMX In and DMX Thru connectors: Five-pin XLR connectors for DMX/RDM in and thru.
K	Power In and Power Thru connectors: powerCON® TRUE1 TOP connectors for power in and thru.
L	Battery connector: Three-pin XLR connector for battery power. Connect the fixture to battery power only when AC power is not available. Maximum fixture output may be reduced when powered by battery.

User Interface

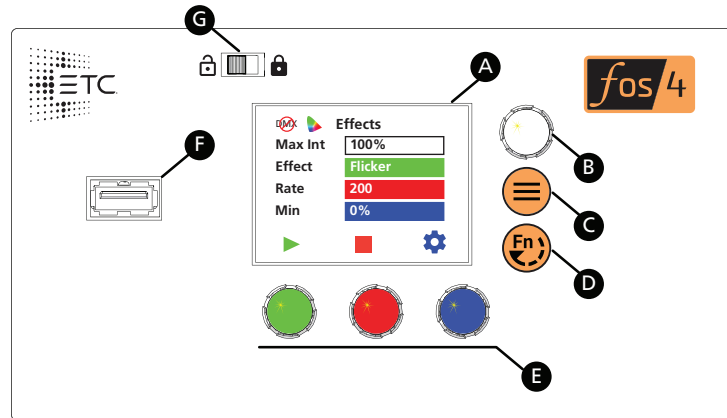

A	<p>Display: The colors of options on the display correspond to the colors of the encoders below the display (E) and the Intensity encoder to the right of the display (B). See Display on the facing page.</p>
B	<p>Intensity encoder:</p> <ul style="list-style-type: none"> • When in DMX mode, press the Intensity encoder to enter Focus mode when focusing the fixture. • When configuring the fixture in one of the stand-alone modes, press the Intensity encoder to toggle between the current intensity and 0, or turn the Intensity encoder to modify the white fields on the display. See Use Fixture in Stand-alone Mode on page 18. • When navigating from the Main Menu screen, turn the Intensity encoder to scroll through menu options, and then press the Intensity encoder to select a menu option.
C	<p>Menu button: Press to view the Main Menu screen and configure the fixture. Press the button again to return to the previous screen when you are setting configuration options.</p>
D	<p>Function button: Press the button, use the Intensity encoder to navigate to one of the following modes, and then press the Intensity encoder to select it:</p> <ul style="list-style-type: none"> • DMX: View and set DMX parameters for the fixture. • Studio: Use one of three studio (white light) presets, or customize the presets. • Color: Use one of 12 color presets, or customize the presets. • Gel: Choose from a list of common gel colors. • Effects: Use one of 12 effects, or customize the effects. • Preset: Use one of 12 presets (color preset + fade time), or customize the presets. <p>See Use Fixture in Stand-alone Mode on page 18 and Use Fixture in DMX Mode on page 11.</p>
E	<p>Encoders (Red, Green, Blue): The colors of encoders correspond to options on the display. Press to activate the options at the bottom of the display, or turn to modify the values on the display.</p>
F	<p>USB port: Use for updating firmware, saving and loading fixture configuration settings, or saving error logs via a flash drive. See Troubleshooting and Maintenance on page 26.</p>
G	<p>UI lock: Set this switch to lock the UI. This prevents inadvertent changes to the UI. See Lock the Display on page 25.</p>

Display

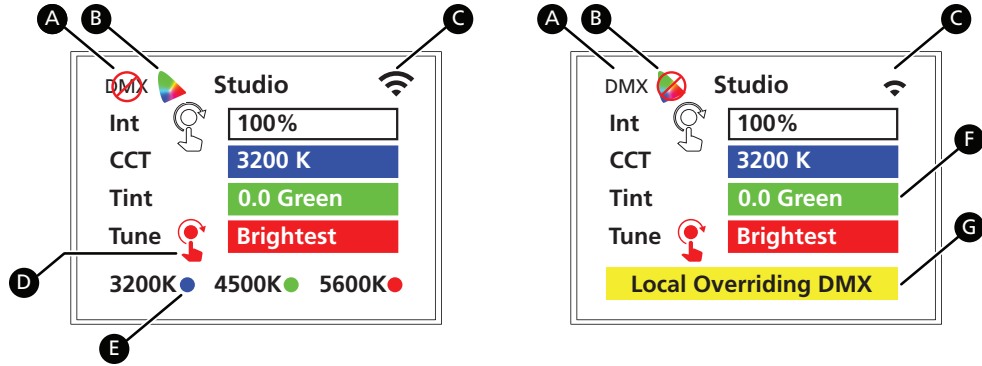

A	DMX indicator: Appears solid when DMX is present, and blinks with a red circle-and-slash when DMX is lost.
B	Gamut indicator: Red circle-and-slash indicates when the current color is out-of-gamut.
C	Wireless indicator: Displays when the fixture is receiving wireless DMX. See Set Up Multiverse Wireless Communication on page 24 . <ul style="list-style-type: none"> Signal strength is indicated by the number of bars (3 bars is highest quality, 1 bar is lowest quality). The wireless indicator appears solid when the fixture is receiving DMX, and blinks when DMX is lost. When the fixture is not connected to a transmitter, the wireless indicator does not display.
D	Press-and-turn: Indicates that additional options are available when you press and turn the encoder. See Studio Mode on page 19 .
E	Encoder press: Press the matching encoders to activate the options on the bottom row of the display.
F	Encoder turn: Turn the matching encoders to modify the values in the fields.
G	Messages and warnings: Text at the bottom of the screen provides helpful information in yellow (for example, "Config Received" or "DMX Control Resumed") or important warnings in red (for example, "LED High Temp" or "Array Failure").

What's Controlling the Fixture?

The fos/4 Fresnel follows two rules to determine what is controlling the fixture:

- **Latest Takes Precedence:** Whatever change in level or color that the fixture receives most recently is the one that the fixture follows.
- **Wired DMX over Wireless DMX:** If both wired DMX and wireless DMX are present, the fixture follows the wired DMX.

Sample Event	What's Controlling the Fixture?
You select a Gel in the Gel stand-alone screen.	Local control (stand-alone Gel)
The fixture receives wired DMX.	Wired DMX
DMX is lost.	Local control (stand-alone Gel)
The fixture receives wireless DMX.	Wireless DMX
The fixture receives wireless DMX and wired DMX.	Wired DMX
You select a Preset in the Preset stand-alone screen.	Local control (stand-alone Preset)
The fixture receives wired DMX	Wired DMX

Set Up and Focus the Fixture



WARNING: Note the following safety warnings before use:

- Only use mounting hardware that is rated for the total weight of the fixture and accessories.
- In addition to primary suspension, attach a safety cable (or other approved safety device) to the fixture. Safety cables must be rated to support ten times the fixture weight. Consult local standards to ensure that safety cables meet all requirements. See [Mount the Fixture below](#).
- Check that the accessory holder is locked and that any accessory safety cables are connected before mounting the fixture.

AVERTISSEMENT : Prendre connaissance des avertissements de sécurité suivants avant toute utilisation :

- N'utilisez que de la quincaillerie de montage adaptée au poids total des projecteurs et des accessoires.
- En plus de la suspension principale, fixez une chaîne de sécurité (ou tout autre dispositif de sécurité homologué) au projecteur. Les chaînes de sécurité doivent être en mesure de supporter dix fois le poids du projecteur. Consultez les normes locales pour vous assurer que les câbles de sécurité respectent toutes les exigences.
- Vérifiez que le porte-accessoires est verrouillé et que les élingues de tous les accessoires sont bien attachées avant de monter le projecteur.

Mount the Fixture

You can mount the fixture using a clamp, baby-pin (16 mm) receiver, or spigot on the yoke (A), or you can set the fixture on a flat surface. When suspending the fixture, make sure to secure the fixture with an appropriate safety cable at the safety cable attachment point (B).



CAUTION: When moving the yoke, do not overtighten the bolts. Minimum torque is 2.82 N·m (25 in-lb), and maximum torque is 3.95 N·m (35 in-lb).

If necessary, move the adjustable yoke (D) to balance the fixture. Use a 13 mm socket wrench to loosen the bolt and shift the yoke position, and then tighten the bolt to secure the yoke.

Add Accessories

You can use up to two standard accessories (one scrim and one additional accessory, such as a barn door) in the accessory holder.

1. Unlock the accessory holder on either side by pressing the spring-release and rotating the accessory holder lock (C).
2. Slide accessories into the accessory slots.
3. Lock the accessory holder by rotating the accessory holder lock back into place.
4. If necessary, move the adjustable yoke (D) to balance the fixture when using larger or heavier accessories.

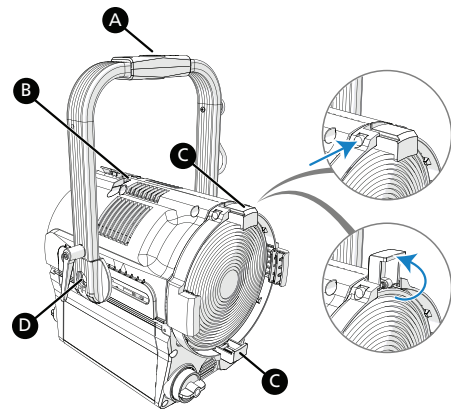

Connect Power and Data

1. Attach five-pin XLR cable to the DMX In connector (if using external control).
2. Plug the XLR cable (if using) into the DMX source or data daisy-chain.
3. Use the DMX Thru connectors to connect up to 32 device loads on the DMX daisy chain.
4. Are you using AC power or battery power?
 - AC power: Continue to step 5.
 - Battery power: Continue to step 6.
5. Use the Power Thru connectors to connect other fixtures using the following recommended guidelines, and then continue to step 6:
 - Power Thru: Link up to 6 additional medium (FL7 or FD7) fixtures (12 A max) or up to 4 additional large (FL10 or FD10) fixtures (12 A max) via Power Thru connector when using an R20 Relay Module (consult breaker-trip curves when using other equipment).
6. Supply power to the fixture in one of these ways:
 - Attach the power cable to the Power In connector, and then plug the power cable into AC power (100–240 VAC, 50/60 Hz) on a non-dimmable circuit.
 - Attach the three-pin XLR cable to the Battery connector, and then plug the cable into the battery (24–36 VDC). Cable must be rated for 10 A or greater.

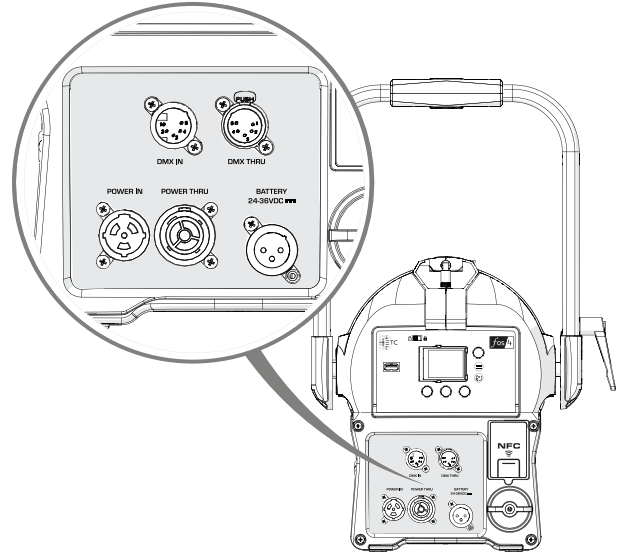

CAUTION: Do not connect the fixture to the battery when AC power is present. Maximum fixture output may be reduced when the fixture is connected to battery power.

Battery Pinout

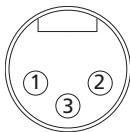

Pin	Description
1	Negative
2	Positive
3	Not used

Focus the Fixture

1. Apply power to the fixture, and wait until the fixture has booted up (the ETC splash screen displays during boot up).
2. Press any encoder to "wake" the display.
3. What screen is currently displayed?
 - **DMX:** Press any encoder to leave the view-only screen, and then press the Intensity encoder to turn on the LED array. The display shows a timeout countdown to indicate how long the LED array will remain on at 100% intensity. You can turn the Intensity encoder to reset the timeout countdown to 5 minutes.
 - **All other screens (Studio, Preset, etc.):** Press the Intensity encoder to turn on the LED array, and turn the Intensity encoder to adjust the intensity.
4. Adjust the fixture to the desired position.
5. Rotate the zoom knob on either side of the fixture to adjust from spot to flood.
6. Press the Intensity encoder to turn off the LED array.

Use Fixture in DMX Mode

After you connect power and data to the fixture and provide DMX, press the **Function** button (Fn), use the Intensity encoder to navigate to **DMX Mode**, and then press the Intensity encoder to select it. In the **DMX** screen, you can set the DMX address, DMX mode, and DMX loss behavior.



Note: You can also set these values using RDM, or by pressing the **Menu** button (☰), turning the Intensity encoder to navigate to **DMX Settings**, and then pressing the Intensity encoder to select it. Use the **Menu** button to change DMX settings when using the fixture in stand-alone mode.

The **DMX** screen displays the current DMX values. Press any of the encoders to "wake" the display, and then press any of the encoders to edit the values. The colors of the encoders correspond to options on the display. Turn an encoder to modify the corresponding value, and then press the encoder to save all values on the screen.

After you wake the display, you can press the Intensity encoder to enter Focus mode. See [Focus the Fixture on the previous page](#).

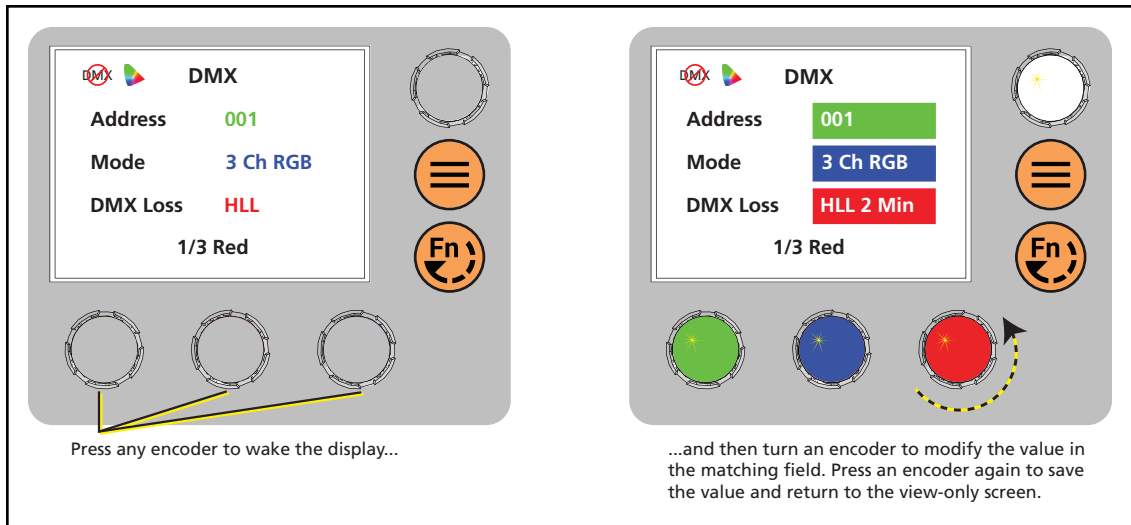

Note: If the colors on the display or on the encoders are difficult to discern, you can navigate based on position rather than color:

- Top value = Left encoder
- Middle value = Center encoder
- Bottom value = Right encoder

Set DMX Address

In the **DMX** screen, turn the green encoder to set the DMX address. The default address is 001.

Set DMX Mode

In the **DMX** screen, turn the blue encoder to set the DMX mode.

- **Direct:** Direct control of emitters.
- **Expanded:** Combines RGB control with Studio control. The **Mix** control channel in **Expanded** mode moves control from full **RGB** mode to full **Studio** mode.
- **Studio:** **CCT** (Correlated Color Temperature) control, **Tint** control (from -10 to 10 green), and **Tuning** control ranging from **Brightest** to **Spectral**. This is the default mode.
- **3 Ch RGB:** Standard RGB control. In **RGB** mode, the **Curve** is always set to **Incandescent** and the **Fan** is always set to **Auto**.
- **1 Channel:** Intensity control for preset 1. (See [Preset Mode on page 23.](#)) In **1 Channel** mode, the **Curve** is always set to **Incandescent** and the **Fan** is always set to **Auto**.
- **Effects:** DMX control for the same effects available in stand-alone **Effects** mode.
- **HSIC:** Hue, Saturation, Intensity, and Color Temperature (white point) for compatibility with HSI console profiles.

DMX Modes

	Direct (Daylight HDR)	Direct (Lustr X8)	Expanded	Studio	3 Ch RGB	1 Channel	Effects	HSIC
RDM ID ►	1	1	2	3	4	5	6	7
DMX Channel ▼								
1	Intensity	Intensity	Intensity	Intensity	Red	Intensity	Action†	Hue Coarse
2	Deep Red	Deep Red	CCT*	CCT*	Green		Effect†	Hue Fine
3	Red	Red	Tint*	Tint*	Blue		Rate†	Saturation
4	Mint	Amber	Tuning*	Tuning*			Intensity	Intensity
5	Cyan	Lime	Mix*	Strobe*			Min. Intensity†	CCT*
6	Blue	Green	Red	Curve*			Frequency†	Strobe*
7	Indigo	Cyan	Green	Fan*			Max. Intensity†	Curve*
8	Strobe*	Blue	Blue				Style‡	Fan*
9	Curve*	Indigo	Strobe*				Preset†	
10	Fan*	Strobe*	Curve*				CCT*	
11		Curve*	Fan*				Tint*	
12		Fan*						

* See [DMX Control Channels on the facing page](#) for the DMX values that set these parameters.

† See [DMX Control Channels: Effects on page 14](#) for the DMX values that set these parameters.

‡ See [DMX Control Channels: Effect Styles on page 15](#) for the DMX values that set this parameter.

DMX Control Channels

Parameter	DMX Value	Description	Comments
CCT	0	3200 K	
	1–165	1900–6000 K	CCT values increase by 25 for each DMX value (1 = 1900 K, 2 = 1925 K, etc.).
	166–254	6050–10,450 K	CCT values increase by 50 for each DMX value (166 = 6050 K, 167 = 6100 K, etc.).
	255	5600 K	
Curve	0–9	Incandescent	
	10–19	Linear	
	20–29	Incandescent Red Shift	In Direct Mode, the fixture uses Incandescent instead of Incandescent Red Shift.
	30–39	Linear Red Shift	In Direct Mode, the fixture uses Linear instead of Linear Red Shift.
	40–49	Quick	Incandescent curve with DMX smoothing turned off
	50–255	Reserved	All modes use Incandescent in the range of DMX values for Reserved.
Fan	0–9	Auto	
	10–19	Off	When the fixture gets too hot, the fixture reduces the intensity instead of turning on the fan.
	20	Slow	Minimum fan speed. When the fixture gets too hot, the fixture reduces the intensity instead of adjusting the fan.
	21–248	Linear Increase in Speed	When the fixture gets too hot, the fixture reduces the intensity instead of adjusting the fan.
	249	Fast	Maximum fan speed (100%). When the fixture gets too hot, the fixture reduces the intensity instead of adjusting the fan.
	250–255	Auto	
Mix	0	Full Studio	
	1–254	Linear interpolation from Studio to RGB	
	255	Full RGB	
Strobe	0	No Strobe	Shutter open
	1–40	Dark Strobe	Range is 1–40 Hz.
	41–80	Bright Strobe	Range is 1–40 Hz.
	81–120	Pulse Strobe	Strobe includes a fade up and fade down on each pulse.
	121–160	Random Strobe	Strobe pulses at random intervals.
	161–200	Flicker Effect	Strobe pulses at random intervals and at random intensity levels.
	201–240	No Strobe	Shutter open
	241–254	LEDs Off	Shutter closed
	255	No Strobe	Shutter open

Parameter	DMX Value	Description	Comments
Tint	0	Neutral	
	1–127	Linear between +10 and 0	Tint shifts toward green (+10) as the DMX value decreases to 1.
	128	Neutral	
	129–255	Linear between 0 and -10	Tint shifts toward magenta (-10) as the DMX value increases to 255.
Tuning (Color calculation method)	0–49	Brightest	Calculation uses a combination of LEDs to produce the brightest version of the selected chromaticity.
	50–99	Spectral (backward-compatible*)	Calculation uses a combination of LEDs to produce the best spectral match of the selected chromaticity. The Spectral option results in higher color rendering, but lower intensity levels. (*In version 1.1 and earlier fixture software releases, this range of values was assigned to the Hybrid color calculation method.)
	100–149	Spectral	Calculation uses a combination of LEDs to produce the best spectral match of the selected chromaticity. The Spectral option results in higher color rendering, but lower intensity levels.
	150–170	Expanded mode: Reserved	This range is reserved for future development, but currently outputs the Brightest color calculation method.
		Studio mode: Metamer (linear adjustment from -1 to 1)	Manually tune the metamer using the Spectral calculation method.
	171–255	Reserved	This range is reserved for future development, but currently outputs the Brightest color calculation method.

DMX Control Channels: Effects

See [Effects Parameters on page 17](#) to see the parameters that are used by each effect.

Parameter	DMX Value	Description	Comments
Action	0–9	Stop	
	10–19	Play	
	20–29	Pause	
	30–255	Reserved	This range is reserved for future development, but currently outputs a Pause action.
Effect	0–9	Flicker	
	10–19	Siren	
	20–29	Lightning	
	30–39	Beacon	
	40–49	TV Set	
	50–59	Projector	
	60–69	Camera	
	70–79	Electrical	
	80–89	Party	
	90–99	Fireworks	
	100–109	Explosion	
	110–255	Reserved	This range is reserved for future development, but currently outputs an Explosion effect.

Parameter	DMX Value	Description	Comments
Frequency	0–9	0.5–1 seconds	
	10–19	1–2 seconds	
	20–29	2–4 seconds	
	30–39	4–8 seconds	
	40–255	Reserved	This range is reserved for future development, but currently outputs a 4–8 second frequency.
Minimum/Maximum Intensity	0	0%	
	1–254	Linear adjustment between 0% and 100%	
	255	100%	
Preset	0–9	1	
	10–19	2	
	20–29	3	
	30–39	4	
	40–49	5	
	50–59	6	
	60–69	7	
	70–79	8	
	80–89	9	
	90–99	10	
	100–109	11	
	110–119	12	
	120–255	Reserved	This range is reserved for future development, but currently outputs preset 12.
Rate	0	10%	
	1–197	Linear adjustment in an increment of 5%	
	198	1000%	
	199–255	1000%	

DMX Control Channels: Effect Styles

Parameter	DMX Value	Description	Comments
Beacon	0–9	Blinking	
	10–19	Fading	
	20–255	Reserved	This range is reserved for future development, but currently outputs the Fading style.
Camera	0–9	Paparazzi	
	10–19	Flash Bulb	
	20–29	Paparazzi	
	30–39	Flash Bulb	
	40–255	Reserved	This range is reserved for future development, but currently outputs the Flash Bulb style.
Electrical	0–9	Surge	
	10–19	Brownout	
	20–255	Reserved	This range is reserved for future development, but currently outputs the Brownout style.

Parameter	DMX Value	Description	Comments
Fireworks	0–9	Rainbow	
	10–19	Custom	
	20–255	Reserved	This range is reserved for future development, but currently outputs the Custom style.
Flicker	0–9	Basic Fire	
	10–19	Glowing	
	20–29	Warm	
	30–39	High Temp	
	40–49	Unnatural	
	50–59	Custom	
	60–69	Basic Fire	
	70–79	Glowing	
	80–89	Warm	
	90–99	High Temp	
	100–109	Unnatural	
	110–119	Custom	
	120–255	Reserved	This range is reserved for future development, but currently outputs the Custom style.
Lightning	0–9	White	
	10–19	Custom	
	20–255	Reserved	This range is reserved for future development, but currently outputs the Custom style.
Party	0–9	Rainbow	
	10–19	Warm	
	20–29	Cool	
	30–39	Whites	
	40–49	Tropical	
	50–59	Patriot	
	60–69	Italy	
	70–79	Brazil	
	80–89	Dominica	
	90–99	Armenia	
	100–109	Ireland	
	110–119	Togo	
	120–129	Zambia	
	130–139	Custom 2	
	140–149	Custom 3	
150–255	Reserved	This range is reserved for future development, but currently outputs the Custom 3 style.	
Projector	0–9	White	
	10–19	Custom	
	20–255	Reserved	This range is reserved for future development, but currently outputs the Custom style.

Parameter	DMX Value	Description	Comments
Siren	0–9	Basic Police	
	10–19	Modern Police	
	20–29	Custom Basic	
	30–39	Custom Modern	
	40–255	Reserved	This range is reserved for future development, but currently outputs the Custom Modern style.
TV Set	0–9	Vibrant	
	10–19	Muted	
	20–29	Custom	
	30–39	Vibrant	
	40–49	Muted	
	50–59	Custom	
	60–255	Reserved	This range is reserved for future development, but currently outputs the Custom style.

Effects Parameters

The table below shows the parameters that can be set for each effect.

Effect	Parameter										
	Action	Effect	Rate	Intensity	Min Int	Freq	Max Int	Style	Preset	CCT	Tint
Flicker	X	X	X	X	X		X	X			
Siren	X	X	X	X			X	X	X		
Lightning	X	X	X	X		X	X	X	X	X	X
Beacon	X	X	X	X	X		X	X	X		
TV Set	X	X	X	X	X		X	X			
Party	X	X	X	X	X		X	X			
Camera	X	X	X	X		X	X	X		X	X
Fireworks	X	X	X	X		X	X	X			
Electrical	X	X	X	X	X	X	X	X	X		
Explosion	X	X	X	X	X	X	X		X		
Projector	X	X	X	X	X		X	X	X	X	X

Set DMX Loss Behavior

In the **DMX** screen, turn the red encoder to set the DMX loss behavior. Options are:

- **Instant:** The fixture immediately goes dark.
- **HLL 2min:** Hold last look for two minutes or until you make local changes. If you make no changes during the two minutes, the fixture fades out over two seconds.
- **HLL:** Hold last look until you make local changes. This is the default setting.
- **Preset 12:** Two-second fade from last look to Preset 12.

Use Fixture in Stand-alone Mode

After you connect power to the fixture, press the **Function** button () , use the Intensity encoder to navigate to one of the following stand-alone modes, and then press the Intensity encoder to select it:

- **Studio:** Use one of three studio (white light) presets, or customize the presets.
- **Color:** Use one of 12 color presets, or customize the presets.
- **Gel:** Choose from a list of common gel colors.
- **Effects:** Use one of 12 effects, or customize the effects.
- **Preset:** Use one of 12 presets (color preset + fade time), or customize the presets.

The colors of options on the display correspond to the colors of the encoders below the display and the Intensity encoder to the right of the display. Turn an encoder to modify the corresponding value on the display, or press an encoder to activate the corresponding option at the bottom of the display. Press the Intensity encoder to toggle between the current intensity and 0%.

If the fixture is connected to other fos/4 Fresnel fixtures that are in the same stand-alone mode, the connected fixtures will play the same preset or effect.



Note: *If the colors on the display or on the encoders are difficult to discern, you can navigate based on position rather than color:*

- *Intensity = Intensity encoder*
 - *From top to bottom (in main section of display):*
 - *Top value = Left encoder*
 - *Middle value = Center encoder*
 - *Bottom value = Right encoder*
 - *From left to right (at bottom of display):*
 - *Left value = Left encoder*
 - *Center value = Center encoder*
 - *Right value = Right encoder*
-

Studio Mode

1. Press the **Function** button (Fn), use the Intensity encoder to navigate to **Studio Mode**, and then press the Intensity encoder to select it.

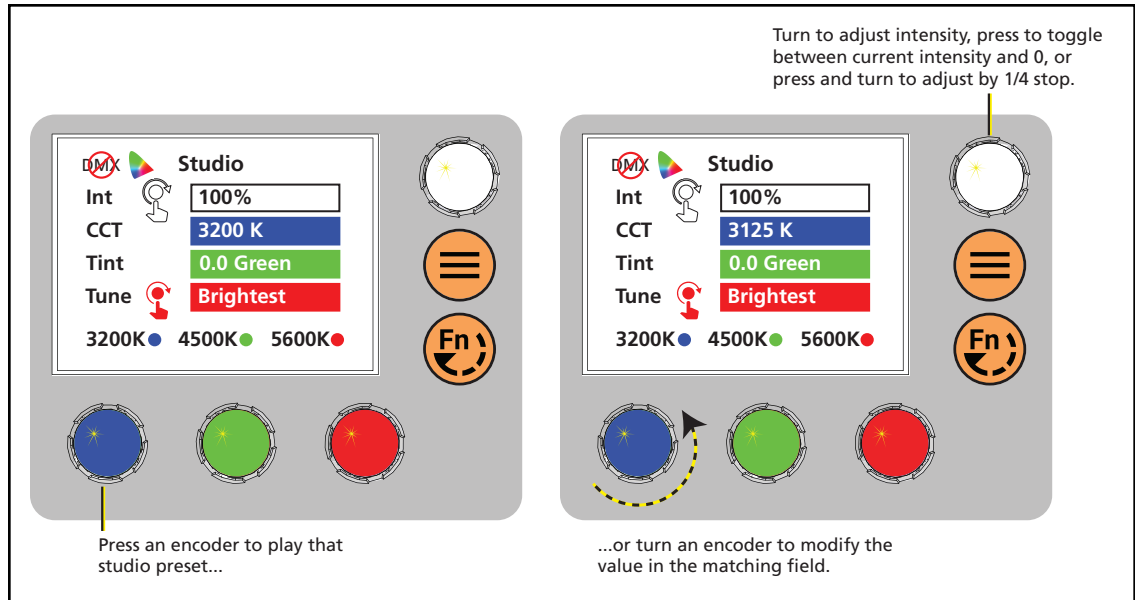

2. Press the color encoder that matches the studio preset you want to use (Blue = 3200 K, Green= 4500 K, Red= 5600 K).

More Options

- **Turn off** the preset: Press the Intensity encoder to toggle the intensity value from the current value to 0. Press the Intensity encoder again to toggle back to the previous intensity value.
- **Modify** the preset: Turn the encoders to change the corresponding values. For example, turn the Intensity encoder to change the intensity value, or turn the blue encoder to change the color temperature value.
- Modify the **intensity**: Turn the Intensity encoder to adjust the intensity, or press and turn the Intensity encoder to adjust the intensity by 1/4 stop.
- Modify the **tuning**: Press and turn the red encoder to change the value to **Metamer**, and then turn the red encoder to change the **Tune** value (the "recipe" of the metamer). Press and turn the red encoder again to return to the **Brightest** or **Spectral** options. For more information on the three methods, see [Tuning \(Color calculation method\) on page 14](#).
- **Revert** to the original preset: Press the encoder that corresponds to the preset again to restore the original values.
- **Save** the modified preset: Press and hold the encoder that corresponds to the preset that you want to re-record. The display shows a three-second countdown before re-recording the preset.

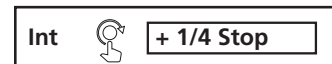

Note: The **CCT**, **Tint**, and **Tune** values match the values that are available when the DMX mode is set to **Studio**. See [DMX Control Channels on page 13](#).

Color Mode

1. Press the **Function** button (Fn), use the Intensity encoder to navigate to **Color Mode**, and then press the Intensity encoder to select it.

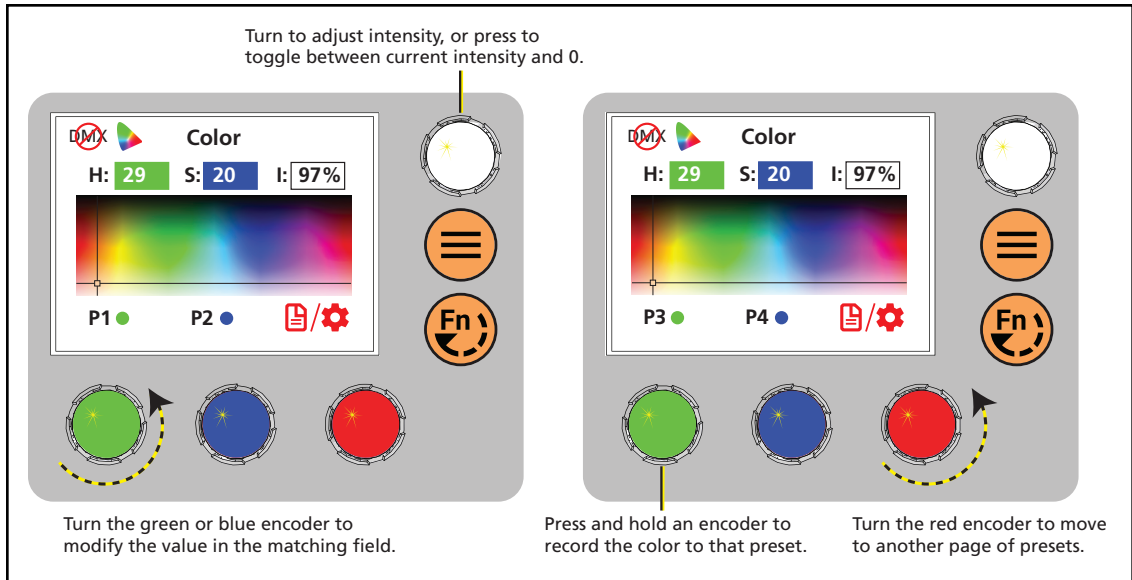

2. Turn the encoders to change the corresponding values. For example, turn the Intensity encoder to change the intensity value, or turn the green encoder to change the hue value. The crosshairs on the display indicate the approximate color.

You can use a preset as a starting point for a color by pressing the color encoder that matches the preset. Turn the red encoder to move to another page of presets.

Number	Preset
1	3200 K
2	4500 K
3	5600 K
4	Yellow
5	Dark Straw
6	Red

Number	Preset
7	Medium Pink
8	Magenta
9	Medium Blue
10	Primary Blue
11	Blue Green
12	Green

More Options

- **Turn off** the color: Press the Intensity encoder to toggle the intensity value from the current value to 0. Press the Intensity encoder again to toggle back to the previous intensity value.
- **Revert** to the original color of a preset: Press the encoder that corresponds to the preset again to restore the original values.
- **Save** the color to a preset: Press and hold the encoder that corresponds to the preset that you want to re-record. The display shows a three-second countdown before re-recording the preset. Changes that you make to presets in the **Color** screen also affect presets in the **Effects** screen and the **Preset** screen.
- **Change** the color selection mode: Press the red encoder (for the **Settings** icon) to change between **Hue/Saturation** (default color selection mode) and **x,y**. In **x,y** mode, you set the **x** and **y** coordinates within the CIE 1931 chromaticity diagram.

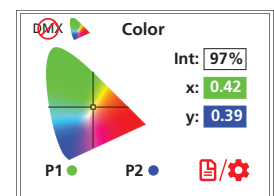

Gel Mode

1. Press the **Function** button (Fn), use the Intensity encoder to navigate to **Gel Mode**, and then press the Intensity encoder to select it.

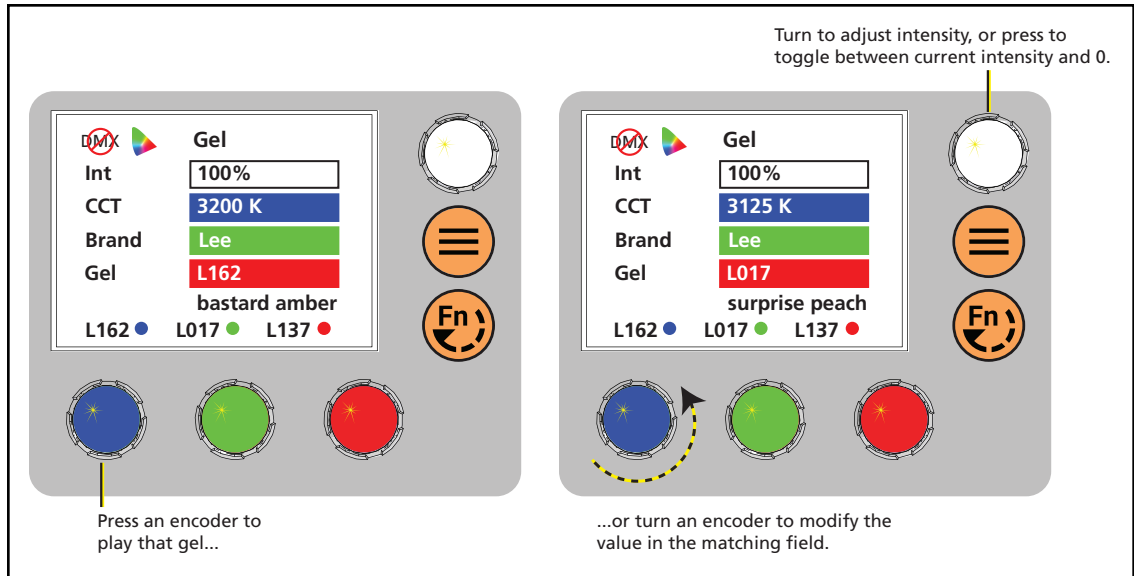

2. Turn the encoders to change the corresponding values. For example, turn the red encoder to change the **Gel** value, or turn the blue encoder to change the **CCT** value.

More Options

- **Turn off** the gel: Press the Intensity encoder to toggle the intensity value from the current value to 0. Press the Intensity encoder again to toggle back to the previous intensity value.
- **Save** the color to a gel preset: Press and hold an encoder to save the current gel to that encoder. The display shows a three-second countdown before re-recording the gel preset.

Effects Mode

1. Press the **Function** button (Fn), use the Intensity encoder to navigate to **Effects Mode**, and then press the Intensity encoder to select it.

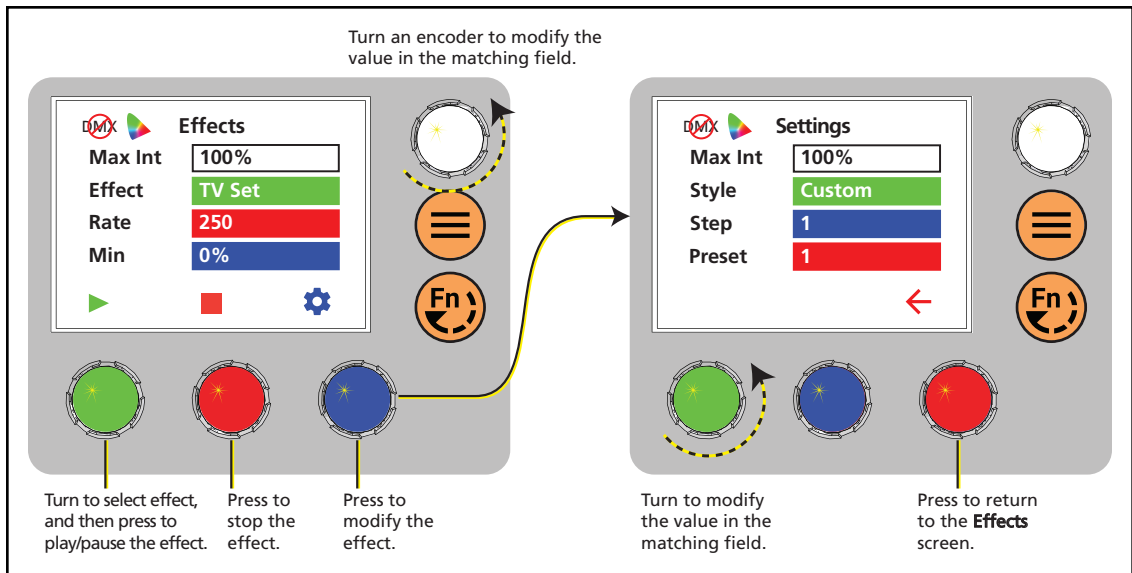

2. Turn the green encoder to select an effect, and then press the encoder to play the effect.

Effect	Description
Flicker	Fire or candle
Siren	Police or emergency vehicle lights
Lightning	Lightning strikes
Beacon	Rhythmic flashing
TV Set	Flickering television screen
Projector	Flickering film projector

Effect	Description
Camera	Paparazzi flashbulbs
Electrical	Occasional increases in intensity
Party	Rhythmic pulsing with bumps through colors
Fireworks	Bursts in random colors that fade
Explosion	Bursts in a selected color that fade
Sequence	Series of presets

More Options

- **Pause** the effect: Press the green encoder again. The green encoder toggles between play and pause. When you press the green encoder to play the effect again, the fixture resumes the effect from where you paused it.
- **Stop** the effect: Press the red encoder. When you press the green encoder to play the effect again, the fixture plays the effect from the beginning.
- **Modify** the effect: Turn the encoders to change the corresponding values. To modify the effect further, press the blue encoder (for the **Settings** icon ⚙️) to modify the settings for the effect.
- **Push** the effect to connected fixtures: Press the **Menu** button (☰), and then use the Intensity encoder to navigate through the menu: **Local Settings > Push Effects**. When the screen prompts you to confirm, press the green encoder (for the **OK** icon ✓) to continue.

Preset Mode

1. Press the **Function** button (Fn), use the Intensity encoder to navigate to **Preset Mode**, and then press the Intensity encoder to select it.

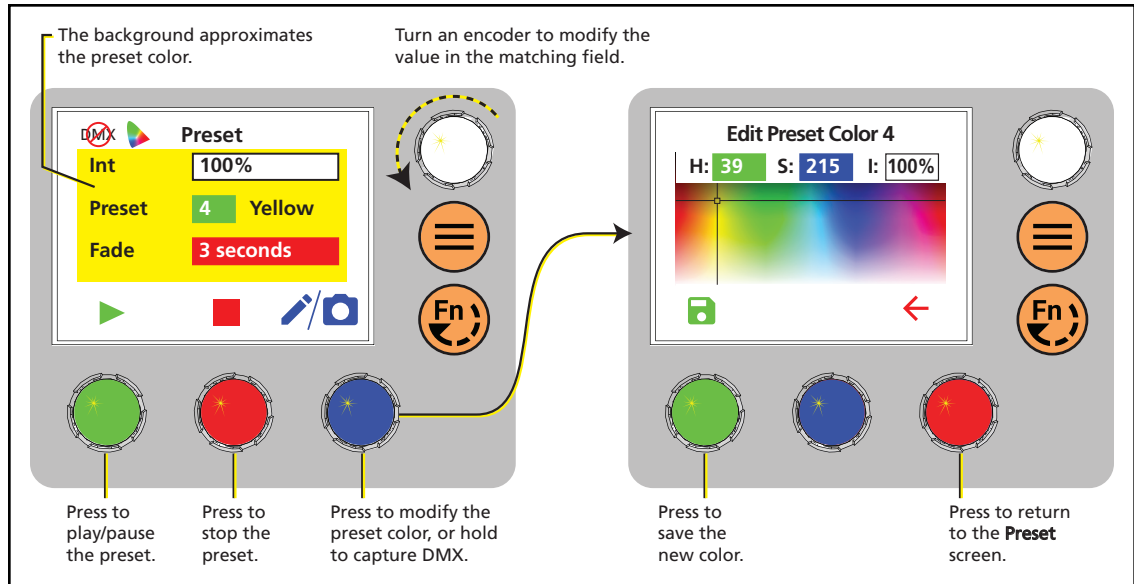





2. Turn the green encoder to select a preset, and then press the encoder to play the preset.

Number	Preset
1	3200 K
2	4500 K
3	5600 K
4	Yellow
5	Dark Straw
6	Red

Number	Preset
7	Medium Pink
8	Magenta
9	Medium Blue
10	Primary Blue
11	Blue Green
12	Green

More Options

- **Pause** the preset fade: Press the green encoder to toggle between play and pause.
- **Stop** the preset: Press the red encoder.
- **Modify** the preset: Turn the Intensity encoder to change the intensity, or turn the red encoder to change the fade value.
- **Capture** the current DMX look: Press and hold the blue encoder (for the **Snapshot** icon ). The display shows a 3-second countdown before re-recording the preset. Capture is limited to three DMX modes: **3 Ch RGB**, **Studio**, and **Expanded**.
- **Modify** the preset **color**: Press the blue encoder (for the **Edit** icon ). In the **Edit Preset Color** screen, turn the encoders to change the corresponding values. The crosshairs on the display indicate the approximate color. Press the green encoder (for the **Save** icon ) to save the new color to the preset.
- **Push** the preset to connected fixtures: Press the **Menu** button () , and then use the Intensity encoder to navigate through the menu: **Local Settings** > **Push Presets**. When the screen prompts you to confirm, press the green encoder (for the **OK** icon ) to continue.

Use Wireless Control

Set Up Multiverse Wireless Communication

You can use a City Theatrical Multiverse® transmitting device to wirelessly configure and control the fixture. For information on using Multiverse products, see the documentation provided with the products.



Note: For additional guidance and troubleshooting resources when setting up your wireless system, download the *Multiverse Wireless Setup Information Guide* at etcconnect.com.

To use Multiverse wireless communication, configure the Multiverse settings on the fixture.

1. Press the **Menu** button (⊖), turn the Intensity encoder to navigate to **Multiverse Settings**, and then press the Intensity encoder to select it.
2. Turn the Intensity encoder to set the **Universe** value.
3. Turn the green encoder to enter the **SHoW ID** value. This value must match the SHoW ID value on the Multiverse transmitting device. The default value is 24100.
4. Turn the blue encoder to enter the **SHoW Key** value. This value must match the SHoW Key value on the Multiverse transmitting device.
5. Turn the red encoder to set the **Power** value. This value sets the power level of the wireless transmitter on the fixture. Set the value to the minimum level required for successful communication between transmitters and fixtures. Excess power output can cause reflections and can degrade performance.
6. Press the green encoder for the **Save** button (⊕) to save your settings, or press the red encoder for the **Cancel** button (⊗) to discard your changes.

When the fixture is connected to a Multiverse transmitter:

- The wireless indicator on the main screen (📶) indicates signal strength by the number of bars (3 bars is highest quality, 1 bar is lowest quality).
- The wireless indicator appears solid when the fixture is receiving DMX, and blinks when DMX is lost. When the fixture is not connected to a transmitter, the wireless indicator does not display.
- The **Multiverse Settings** screen displays the signal quality (percentage) and signal strength (RSSI). For information on these values, download the *Multiverse Wireless Setup Information Guide* at etcconnect.com.

Configure Fixtures Using the Set Light App

Download the Set Light app to a smartphone with NFC functionality, use the app to set fixture parameters, and then tap the smartphone to the NFC tag on the fixture to configure it wirelessly—even when the fixture is not powered on. Or, after you configure the Multiverse settings on the fixture, use the Set Light app to configure one fixture or multiple fixtures wirelessly from a smartphone or tablet. (You must be within Bluetooth range of the Multiverse transmitter or gateway in order to use the app in this mode.) Visit etcconnect.com/Apps for more information about the Set Light app.

Control and Customize the Display

Lock the Display

Set this switch to lock the UI and prevent any changes to the fixture setup. The display indicates when the UI is locked.

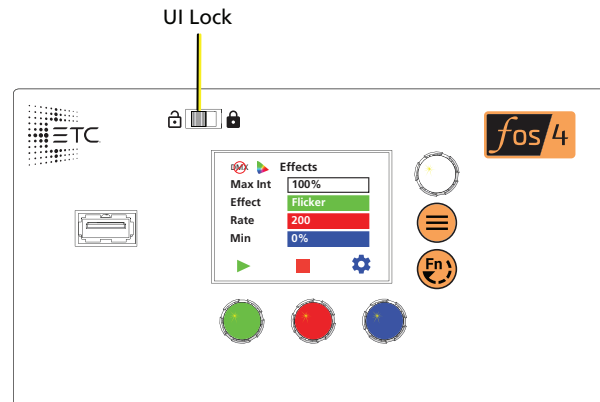

Adjust the Display Settings

1. Press the **Menu** button (☰), turn the Intensity encoder to navigate to **Local Settings**, and then press the Intensity encoder to select it.
2. In the **Local Settings** screen, turn the Intensity encoder to select the display parameter that you want to modify, and then press the Intensity encoder to modify it.
3. Turn the Intensity encoder to modify the value of the parameter, and then press the Intensity encoder to save the value.
4. Press the **Menu** button (☰) or press the red encoder until you return to the **Main Menu** screen when you are done.

Parameter	Description
Backlight	Set the brightness of the display backlight from 10–100%.
Timeout	Set the time that the display will remain illuminated after the last time you press an encoder or button. Options are: <ul style="list-style-type: none">• Never (display is always illuminated)• 30 seconds• 1 minute (default)• 5 minutes• 15 minutes
Display	Sets the behavior of the display in relation to the position of the fixture: <ul style="list-style-type: none">• Auto: Display inverts as the fixture moves.• Normal: Display matches the orientation of the fixture labeling.• Invert: Display is inverted in relation to the orientation of the fixture labeling.
Encoders	Set the brightness of the four encoders from 10–100%.

Troubleshooting and Maintenance

Troubleshooting Checklist

If you cannot find the resources that you need in this document, contact ETC Technical Services (see [Help from ETC Technical Services on page 2](#)).

What I'm Seeing	What Might Be Wrong	What To Try
Color on the fixture does not match another fixture, or color on the fixture does not match expected color output	<ul style="list-style-type: none"> Color is out-of-gamut. Temperature sensor is failing. 	<ul style="list-style-type: none"> Sending an out-of-gamut color to a fixture can result in differences in color output. The gamut indicator on the display indicates if the color is out-of-gamut. See Display on page 7. If the temperature sensor is failing, contact ETC Technical Services for assistance.
Error message "Array Comm" or "Array Failure" displays on screen	Fixture cannot communicate with the LED array.	Contact ETC Technical Services.
Error message "Color Data Fail" displays on screen	Fixture cannot load its color information.	Contact ETC Technical Services.
Error message "LED High Temp" or "Power Budgeting" displays on screen	<ul style="list-style-type: none"> Fan is set to a level that is too low for the current LED intensity. Fan has failed. Temperature sensor is failing. 	<ul style="list-style-type: none"> Verify whether the fan is running. Check the About Sensors screen to view the current fan level. See View Diagnostic Data on page 28. If the temperature sensor is failing, contact ETC Technical Services for assistance.
Error message "Low Battery" displays on screen	Fixture is powered by a battery, and the battery level is low.	Connect the fixture to a fresh battery. Follow the instructions provided with the battery to recharge the low-level battery (providing AC power to the fixture while the battery is connected does not recharge the battery).
<ul style="list-style-type: none"> Wireless indicator () is blinking Fixture is not responding to wireless control Fixture is responding intermittently to wireless control 	<ul style="list-style-type: none"> Fixture is still connected to wired DMX control (via DMX In connector). Wired DMX data takes precedence over wireless DMX data. Other wireless systems are interfering with the Multiverse wireless communication. Fixture antennas or Multiverse product antennas are not oriented optimally. Multiverse transmitter is not located optimally. 	See the <i>Multiverse Wireless Setup Information Guide</i> at etcconnect.com for guidance on setting up wireless communication. <ul style="list-style-type: none"> Disconnect the DMX in cable. Change the radio settings to different channels. Minimize overlap with other Wi-Fi sources. Move the antennas on the fixtures, Multiverse products, or both. Move the Multiverse transmitter.
Error message "No Bundle" displays on screen	Fixture does not have a firmware bundle stored internally. This may indicate that a firmware update failed.	Update the firmware again (see Update Firmware on page 30). If the error persists, contact ETC Technical Services.
Error message "USB Error" displays on screen	Fixture cannot read the USB drive.	Remove and then re-insert the USB drive. If the error message continues to display, try a different USB drive.
Fan is loud	DMX value for fan operation is set too high.	Verify that the DMX value is appropriate for the fan channel. See DMX Control Channels on page 13 .
Fixture is flickering	Fixture is receiving bad DMX.	Check the About Control screen to verify that the DMX controller is sending good DMX. See View Diagnostic Data on page 28 . If the DMX data looks good, then contact ETC Technical Services.

What I'm Seeing	What Might Be Wrong	What To Try
Fixture is stuck on the last look sent via DMX	The fixture may not be receiving DMX. (If you have not changed the DMX Loss behavior, the default setting is HLL , which causes the fixture to hold the last look until you make local changes.) The DMX indicator on the display appears solid when DMX is present, and blinks with a red circle-and-slash when DMX is lost. See Display on page 7 .	<ul style="list-style-type: none"> • Check the DMX In connector and cable. • Check that the DMX source is sending data.

Adjust the Pulse Width Modulation (PWM)

If you are encountering flickering in recorded video, you can adjust the Pulse Width Modulation (PWM) to correct it.

1. Press the **Menu** button (⊖), turn the Intensity encoder to navigate to **Local Settings**, and then press the Intensity encoder to select it.
2. In the **Local Settings** screen, turn the Intensity encoder to select the **PWM** parameter, and then press the Intensity encoder to select between the two options:
 - **High**: The 25 kHz setting prevents flickering when recording video. This is the default setting.
 - **Low**: The 5 kHz setting provides greater control of low-end dimming.
3. Press the **Menu** button (⊖) or press the red encoder until you return to the **Main Menu** screen when you are done.

Test the Emitters

As part of troubleshooting any issues with a fixture, you can test the emitters, either as a group or individually by color.

1. Press the **Menu** button (⊖), and then use the Intensity encoder to navigate through the menu: **Diagnostics > Test**.
2. In the **Test** screen, use the blue encoder to select the emitters to test, and the green encoder to set the level for the emitters:
 - Press the blue encoder to select all emitter colors, or turn the encoder to select an individual emitter color. (**De** = Deep red, **Re** = Red, etc.)
 - Press the green encoder to toggle between off and full (**FL**) for the selected emitters, or turn the encoder to set a specific level (0%–100%).
3. If necessary, use the Intensity encoder to set the intensity level for the emitter test.
4. Press the **Menu** button (⊖) or press the red encoder until you return to the **Main Menu** screen when you are done.



Note: If you don't press the **Menu** button (⊖) or press the red encoder to return to the **Main Menu** screen when you are done, the **Test** screen will time out based on the **Timeout** setting (see [Adjust the Display Settings on page 25](#)). However, if you set the **Timeout** setting to **Never** and do not exit the **Test** screen, the fixture will remain in test mode (overriding any other instructions to the fixture) until you return to the **Test** screen and exit it.

View Diagnostic Data

As part of troubleshooting any issues with a fixture, ETC Technical Services may ask that you view diagnostic data on the fixture.

1. Press the **Menu** button (⊖), turn the Intensity encoder to navigate to **Diagnostics**, and then press the Intensity encoder to select it.
2. In the **Diagnostics** screen, turn the Intensity encoder to select the diagnostics category, and then press the Intensity encoder to view the data for that category. Use the Intensity encoder in a given screen to navigate through the values in that screen.

Category	Description
About Fixture	Fixture data: <ul style="list-style-type: none">• Version numbers• Serial number• RDM ID• RDM Label
About Control	Information on the current DMX or Multiverse control data. Includes network statistics to aid in diagnosing DMX issues or connectivity issues. Turn the green encoder to change the data display between DMX and Multiverse.
About Sensors	<ul style="list-style-type: none">• Usage data for fixture power, fan, and battery.• Temperatures for the fixture components and fan usage; can aid in diagnosing issues with color mismatches between fixtures or overuse of fan.
Test	Use this option to test the emitters. See Test the Emitters on the previous page .
About Color	The target color sent to the fixture, the actual (current) color generated by the fixture, and whether the color sent to the fixture is out-of-gamut.
Events	Log of the last 50 changes to the fixture settings, identified by the source of the change (for example, via DMX, RDM, or the UI). The most recent change is first in the list. You can export the event log to a USB drive to aid in troubleshooting. See Export Fixture Event Log on page 30 .

3. Press the **Menu** button (⊖) or press the red encoder until you return to the **Main Menu** screen when you are done.

View Battery Level

1. Press the **Menu** button (⊖), turn the Intensity encoder to navigate to **Diagnostics**, and then press the Intensity encoder to select it.
2. In the **Diagnostics** screen, turn the Intensity encoder to select **About Sensors**, and then press the Intensity encoder to view the sensor data. The **Battery** field displays the current battery level.
3. Press the **Menu** button (⊖) or press the red encoder until you return to the **Main Menu** screen when you are done.

Set a Low Battery Warning



CAUTION: *Do not connect the fixture to the battery when AC power is present. Maximum fixture output may be reduced when the fixture is connected to battery power.*

When the fixture is using battery power and the battery power is low, the fixture can display an error and send a notification to RDM controllers. You can customize the voltage level for the low battery warning.

1. Press the **Menu** button (⊖), turn the Intensity encoder to navigate to **Local Settings**, and then press the Intensity encoder to select it.
2. In the **Local Settings** screen, turn the Intensity encoder to select **Battery Alarm**, and then press the Intensity encoder to modify it.
3. Turn the Intensity encoder to set the voltage level for the low battery warning, and then press the Intensity encoder to save the value.
4. Press the **Menu** button (⊖) or press the red encoder until you return to the **Main Menu** screen when you are done.

Export Fixture Data for Troubleshooting

As part of troubleshooting any issues with a fixture, ETC Technical Services may ask that you export fixture data to a USB drive and then send the data for further analysis.

Export Fixture Data

The fixture routinely saves data. You can export the data to a USB drive to aid in troubleshooting any issues with the fixture.

1. Insert the USB drive in the USB port on the rear of the fixture (see [User Interface on page 6](#)).
2. Press the **Menu** button (⊖), and then use the Intensity encoder to navigate through the menu: **Local Settings > USB > Save Data**.
3. The display shows the file name to be saved (for example, f4data00.xml). Press the green encoder (for the **Save** icon ) to save the file to the USB drive.

The display returns to the **USB** screen when the process is complete. The saved data includes the following parameters:

- Power consumption
 - Temperatures (PSU, Control, and LED)
 - Control mode
 - DMX parameters
 - Run time in hours
4. Remove the USB drive from the USB port.

Export Fixture Event Log

The fixture routinely saves the last 50 changes to the fixture settings in an event log. The log identifies the way in which the settings were changed (for example, whether the settings were changed using the UI or via RDM). You can export the event log to a USB drive to aid in troubleshooting any issues with the fixture.

1. Insert the USB drive in the USB port on the rear of the fixture (see [User Interface on page 6](#)).
2. Press the **Menu** button (☰), and then use the Intensity encoder to navigate through the menu: **Local Settings > USB > Save Events**.
3. The display shows the file name to be saved (for example, f4log00.xml). Press the green encoder (for the **Save** icon 🟩) to save the file to the USB drive.

When the display returns to the **USB** screen, the process is complete, and the data is saved to a file on the USB drive.

4. Remove the USB drive from the USB port.

Restore Default Settings

1. Press the **Menu** button (☰), and then use the Intensity encoder to navigate through the menu: **Local Settings > Restore Defaults**.
2. When the screen prompts you to confirm, press the green encoder (for the **OK** icon ✓) to continue. The screen shows a confirmation message after default settings have been restored. After the default settings have been restored, the DMX mode will be **Studio**.

Update Firmware

When fixtures are connected to data, you can update firmware directly using UpdaterAtor. For information on UpdaterAtor, see the *UpdaterAtor Software Quick Guide* and the *UpdaterAtor Software Release Note*, which you can download from etconnect.com.

You can also update firmware using a USB drive. After you update a single fixture using a USB drive, you can update all fixtures that are connected via wired DMX from that fixture.

Update a Single Fixture Using a USB drive

1. Visit etconnect.com or use UpdaterAtor to get the updated firmware file for the fixture, and then save the firmware file to a USB drive. For information on UpdaterAtor, see the *UpdaterAtor Software Quick Guide* and the *UpdaterAtor Software Release Note*, which you can download from etconnect.com.
2. Insert the USB drive in the USB port on the rear of the fixture (see [User Interface on page 6](#)).
3. Press the **Menu** button (☰), and then use the Intensity encoder to navigate through the menu: **Local Settings > USB > Update Firmware**.
4. Use the Intensity encoder to navigate to the firmware update file, and then press the Intensity encoder to begin the firmware update. The firmware update includes several steps:
 - a. Copying the files to the fixture: A progress meter displays as the files are copied to the fixture.
 - b. Verifying the files: The ETC logo displays on the top half of the screen as the fixture verifies the files. You can safely remove the USB drive at this time.
 - c. Updating the fixture: The fixture installs the updated firmware files.

Update All Connected Fixtures

1. After you update the firmware on a fixture, verify that the fixture is not receiving DMX/RDM before you proceed.
2. Press the **Menu** button (☰), and then use the Intensity encoder to navigate through the menu: **Local Settings > Push Firmware**.
3. When the screen prompts you to confirm, press the green encoder (for the **OK** icon ✓) to continue. The updated firmware is copied to all connected fixtures, and the screens on connected fixtures display a progress message ("Firmware RX x%").

Backup and Restore the Fixture Configuration

You can save the fixture settings to a USB drive and then apply those settings to another fixture. You can also use the saved settings as a backup, and then apply the settings to the same fixture to restore it to a previous state.

Back Up Fixture Settings

1. Insert the USB drive in the USB port on the rear of the fixture (see [User Interface on page 6](#)).
2. Press the **Menu** button (☰), and then use the Intensity encoder to navigate through the menu: **Local Settings > USB > Save All Settings**.
3. The display shows the file name to be saved (for example, f4cfg00.xml). Press the green encoder (for the **Save** icon 📁) to save the file to the USB drive.
The display returns to the **USB** screen when the process is complete.
4. Remove the USB drive from the USB port.

Apply (or Restore) Fixture Settings

1. Insert the USB drive that contains the fixture settings file (f4cfgxx.xml) in the USB port on the rear of the fixture (see [User Interface on page 6](#)).
2. Press the **Menu** button (☰), and then use the Intensity encoder to navigate through the menu: **Local Settings > USB > Apply All Settings**.
3. When the screen prompts you to select the fixture settings file, use the Intensity encoder to navigate to the correct file and select it.
The display returns to the **USB** screen when the process is complete.
4. Remove the USB drive from the USB port.

Push Fixture Settings to All Connected Fixtures

1. Press the **Menu** button (☰), and then use the Intensity encoder to navigate through the menu: **Local Settings > Push Settings**.
2. When the screen prompts you to confirm, press the green encoder (for the **OK** icon ✓) to continue. The settings are copied to all connected fixtures, and the screens on connected fixtures display a confirmation message ("Config Received").

Clean the Lens

Clean the lens using a clean, micro-fiber cloth. You can use isopropyl alcohol on the cloth, but do not spray the cleaning solution directly onto the lens or into the interior of the fixture.

Specifications and Reference

For current and complete compliance and specifications, see the fos/4 Fresnel datasheet at etconnect.com.

Environment

The fos/4 Fresnel operates in ambient temperatures of 0°C–40°C (32°F–104°F) and is rated IP20 (for use in dry locations only).

Fixture temperature information:

- Maximum recommended ambient operating temperature: $T_a=40^{\circ}\text{C}$ (104°F)
- Maximum anticipated external surface temperature: $T_{\text{max}}=80^{\circ}\text{C}$ (176°F)
- External temperature after 5 minutes of full-brightness operation at 25°C (77°F) ambient:
 - Medium (FL7 or FD7): 31°C (88°F)
 - Large (FL10 or FD10): 41°C (106°F)
- External Temperature (steady state achieved) at 25°C (77°F):
 - Medium (FL7 or FD7): 41°C (106°F)
 - Large (FL10 or FD10): 45°C (113°F)

Dimensions and Weight

Model	Array Type	Aperture Size	Weight
fos4FL7	Lustr X8	7 in (17.8 cm)	11.1 kg (24.5 lb)
fos4FD7	Daylight HDR		
fos4FL10	Lustr X8	10 in (25.4 cm)	13.4 kg (29.5 lb)
fos4FD10	Daylight HDR		

Electrical

- Operates between 100 VAC and 240 VAC at a frequency of 50/60 Hz.
- Requires power from a non-dimmable source.
- When not connected to AC power, the fixture can be powered by an external battery with a range of 24–36 VDC.
- Link up to 6 additional medium (FL7 or FD7) fixtures (12 A max) or up to 4 additional large (FL10 or FD10) fixtures (12 A max) via Power Thru connector when using an R20 Relay Module (consult breaker-trip curves when using other equipment).

Fixture	Maximum Power Consumption	Inrush (120 V)	Inrush (240 V)
FL7 and FD7	270 W	46.6 A	110.2 A
FL10 and FD10	325 W	46.6 A	110.2 A

Typical Power Consumption		100 V		120 V		230 V	
FL7	Idle Power/Current	7.5 W	0.10 A	8.8 W	0.11 A	8 W	0.09 A
	Direct at Full/Current	179.4 W	1.83 A	177.7 W	1.51 A	172.9 W	0.79 A
FD7	Idle Power/Current	7.5 W	0.10 A	7.7 W	0.11 A	7.6 W	0.09 A
	Direct at Full/Current	218.3 W	2.23 A	219.8 W	1.87 A	219.9 W	0.99 A
FL10	Idle Power/Current	6.6 W	0.09 A	6.9 W	0.10 A	7.0 W	0.08 A
	Direct at Full/Current	282.1 W	2.87 A	280.9 W	2.38 A	275.6 W	1.23 A
FD10	Idle Power/Current	6.6 W	0.09 A	6.9 W	0.10 A	7.0 W	0.08 A
	Direct at Full/Current	306.4 W	3.12 A	303.9 W	2.57 A	298.5 W	1.33 A

RDM Parameters

Parameter	Fixture	Value	Description
Manufacturer ID	All	0x6574	Electronic Theatre Controls
Model ID	fos4FL7	0x0460	fos4 FL7 Lustr X8 or fos4 FL7 Lustr X8 CPU2
	fos4FD7	0x0461	fos4 FD7 Daylight HDR or fos4 FD7 Daylight HDR CPU2
	fos4FL10	0x0470	fos4 FL10 Lustr X8
	fos4FD10	0x0471	fos4 FD10 Daylight HDR
DMX Personality	All	0x00E0	1 = Direct 2 = Expanded 3 = Studio 4 = RGB 5 = 1-channel 6 = Effects 7 = HSIC
DMX Start Address	All	0x00F0	Range = 1–512

Fixture Compliance

For current and complete compliance and specifications, see the fos/4 Fresnel datasheet at etcconnect.com.

FCC Compliance

fos/4 Fresnel

(For any FCC matters):

Electronic Theatre Controls, Inc.
3031 Pleasant View Road
Middleton, WI 53562
+1 (608) 831-4116
etcconnect.com

This device complies with Part 15 of the FCC Rules. Operation is subject to the following two conditions: (1) this device may not cause harmful interference, and (2) this device must accept any interference received; including interference that may cause undesired operation. Visit etcconnect.com/products for current and complete compliance information including FCC compliance.



Note: *This equipment has been tested and found to comply with the limits for a Class A digital device, pursuant to Part 15 of the FCC rules. These limits are designed to provide reasonable protection against harmful interference when the equipment is operated in a commercial environment. This equipment generates, uses, and can radiate radio frequency energy and, if not installed and used in accordance with the instructions, may cause harmful interference to radio communications. Any modifications or changes to this product not expressly approved by Electronic Theatre Controls, Inc. could void the user's authority to operate the product. Operation of this equipment in a residential area is likely to cause harmful interference, in which case the user will be required to correct the interference at their own expense.*

This device contains a wireless module with the following identification numbers:

FCC ID: VU65995

ISED Compliance

This device contains a license-exempt transmitter/receiver that complies with Innovation, Science, and Economic Development Canada's license-exempt RSSs. Operation is subject to the following two conditions:

1. This device may not cause interference.
2. This device must accept any interference, including interference that may cause undesired operation of the device.

Contains IC ID: 7480A-5995

CAN ICES-005 (A)

Conformité ISDE

Cet appareil contient un émetteur/récepteur conforme aux CNR d'Innovation, Sciences et Développement économique Canada (ISDE) applicables aux appareils radio exempt de licence. Son fonctionnement est soumis aux deux conditions suivantes:

1. L'appareil ne doit pas produire d'interférences.
2. L'utilisateur de l'appareil doit accepter toute interférence, même si l'interférence est susceptible d'en compromettre le fonctionnement.

Contient ID IC: 7480A-5995

CAN NMB-005 (A)

EU Declaration of Conformity

This product complies with the essential requirements of the Radio Equipment Directive of the European Union 2014/53/EU (RED).

This product conforms to the following standards:

- ETSI EN 300 328 v2.1.1 (2016)
- ETSI EN 301 489 v2.1.1 (2017)
- ETSI EN 301 489-18 v3.1.1 (2016)

Licensed Software

This product uses licensed software provided by third parties. Please visit etconnect.com/licenses for licensing information.



Corporate Headquarters ■ Middleton, WI, USA | +1 608 831 4116
Global Offices ■ London, UK | Rome, IT | Holzkirchen, DE | Paris, FR | Hong Kong | Dubai, UAE | Singapore
New York, NY | Orlando, FL | Los Angeles, CA | Austin, TX | © 2023 Electronic Theatre Controls, Inc.
Web etconnect.com | **Support** support.etconnect.com | **Contact** etconnect.com/contactETC
Trademark and patent info: etconnect.com/ip | Third-party license agreement info: etconnect.com/licenses
Product information and specifications subject to change. ETC intends this document to be provided in its entirety.
7470M1200-1.3.0 Rev B Released 2023-11