

NanoPix2880HP

from software version: V4.5

Released: 12-2017 - V1.1 - Rev B



Safety Guidelines



» Please read these safety guidelines carefully before you take the NanoPix2880HP into service.

» Check the suitability of the product for the intended use.

» The NanoPix2880HP is not suitable for outdoor use (IP20).



» Do not attempt to repair or dismantle the NanoPix2880HP fixture: Opening and removing the internal covers can result in electrocution or other serious injuries.

» In case of product failure, please contact LDDE or an authorised LDDE-dealership.



» Do not touch the fixture while it is in use.



» Disconnect the fixture from the power supply before re-positioning and cleaning.

» Ensure that when the luminaire systems are installed in decorations, a sufficient clearance of around 30cm is required for adequate cooling and ventilation.

» Protect the fixture from shocks and impacts.

» Protect the fixture from moisture and water and avoid contact with moist or wet appliances.



» Ensure that the fixture is not covered and adequate ventilation is in place.



» Do not insert objects into openings of the housing that are connected to live parts as this can lead to short circuiting. Danger of electric shock and risk of fire.

» The fixture is to be removed from service if:

- there is visible damage
- parts have become loose
- there is visible damage to cable connections

» LDDE products are manufactured and delivered in concordance with EU directive 2002/96/EU of the European Parliament and the Council on Waste Electrical and Electronic Equipment (WEEE). Help protect the environment and dispose of used products at your local recycling station.



Your dealership can offer further advice on correct disposal.

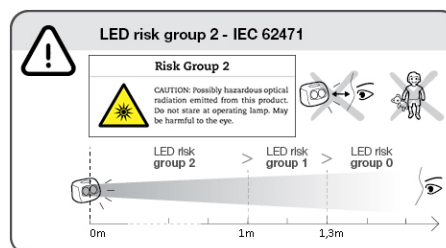

Menu structure

As soon as the NanoPix2880HP is supplied with power, the integrated OLED display lights up. Now, perform the appropriate system configuration on the unit using the control panel located on the top of the unit. It is recommended to carry out all configurations in advance of the installation on the devices. The respective system settings are explained in the following points.

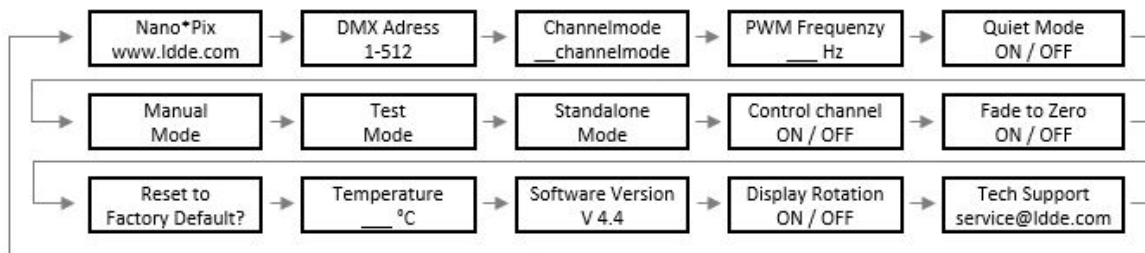

Operation

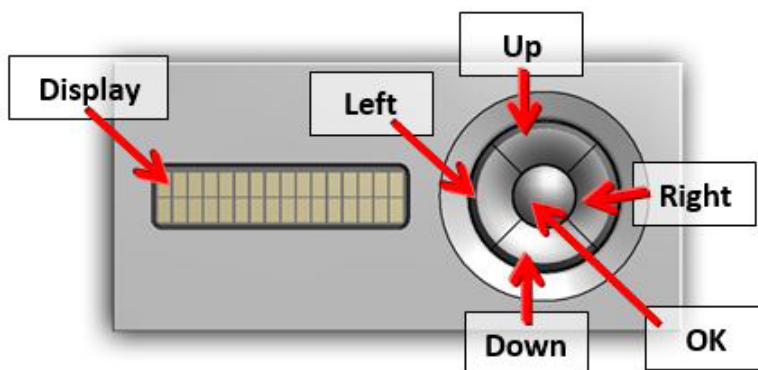

The menu is controlled by 5 buttons: Up, Down, Left, Right and OK.

In the main menu, you can jump through the individual menu items only with Left / Right. If you wish to change a setting, press the OK key, then the setting to be changed will flash. Then use Up / Down to change the setting and confirm with OK. During the saving process, „Saving ...“ is displayed in the lower display line.

DMX address

In this menu the DMX start address is set in the range 1 - 512.

Channelmode

You can choose between 11 DMX modes, each designed for different applications and preferences.

8-bit Mode

CH5 - COLOR MODE (5 CHANNELS):

Only colors (RGB, WW, CW) - No intensity and strobe channel available.

CH7 - NORMAL MODE (7 CHANNELS):

Most common mode with all basic functions.

CH30 - GROUP ARRAY MODE (30 CHANNELS)

The opposite LED modules are controlled as a group with 8-bit dimming.

No intensity and strobe channel available.

CH31 - GROUP ARRAY MASTER MODE (31 CHANNELS)

Same as Ch30 - Group Array Mode, additionally with intensity channel.

CH60 - PIXEL MODE (60 CHANNELS)

Each of the twelve (12) LED modules is individually controlled. No intensity and strobe channel available.

CH62 - PIXEL MASTER STROBE MODE (62 CHANNELS)

Same as Ch60 - Pixel Mode, additionally with intensity and strobe channel.

16-bit Mode

CH10 - HIGH RESOLUTION COLOR MODE (10 CHANNELS):

Same as Ch5 - Color Mode, but with 16-bit dimming.

CH11 - HIGH RESOLUTION COLOR STROBE MODE (11 CHANNELS)

Same as Ch10 - High Resolution Color Mode, additionally with 8-bit strobe.

CH61 - HIGH RESOLUTION GROUP ARRAY MODE (61 CHANNELS)

The opposite LED modules are controlled as a group with 16-bit dimming.

A strobe channel with 8-bit is also available.

CH120 - HIGH RESOLUTION PIXEL MODE (120 CHANNELS)

Each of the twelve (12) LED modules is individually controlled with 16-bit dimming.

CH121 - HIGH RESOLUTION PIXEL STROBE MODE (121 CHANNELS)

Each of the twelve (12) LED modules is individually controlled with 16-bit dimming.

A strobe channel with 8-bits is also available.

Channelmode 8-bit

The following table shows the various available modes for 8-bit control and the DMX channels required for the corresponding mode.

DMX Chart

Ch	LED module	8-bit interpolated	Ch 5	Ch 7	Ch 30	Ch 31	Ch 60	Ch 62
1		Intensity	xxx	1	xxx	1	xxx	1
2	1	R (red)	1	2	1	2	1	2
3		G (green)	2	3	2	3	2	3
4		B (blue)	3	4	3	4	3	4
5		WW (warm white)	4	5	4	5	4	5
6		CW (cold white)	5	6	5	6	5	6
7	2	R (red)	1	2	1	2	6	7
8		G (green)	2	3	2	3	7	8
9		B (blue)	3	4	3	4	8	9
10		WW (warm white)	4	5	4	5	9	10
11		CW (cold white)	5	6	5	6	10	11
12	3	R (red)	1	2	6	7	11	12
13		G (green)	2	3	7	8	12	13
14		B (blue)	3	4	8	9	13	14
15		WW (warm white)	4	5	9	10	14	15
16		CW (cold white)	5	6	10	11	15	16
17	4	R (red)	1	2	6	7	16	17
18		G (green)	2	3	7	8	17	18
19		B (blue)	3	4	8	9	18	19
20		WW (warm white)	4	5	9	10	19	20
21		CW (cold white)	5	6	10	11	20	21
22	5	R (red)	1	2	11	12	21	22
23		G (green)	2	3	12	13	22	23
24		B (blue)	3	4	13	14	23	24
25		WW (warm white)	4	5	14	15	24	25
26		CW (cold white)	5	6	15	16	25	26
27	6	R (red)	1	2	11	12	26	27
28		G (green)	2	3	12	13	27	28
29		B (blue)	3	4	13	14	28	29
30		WW (warm white)	4	5	14	15	29	30
31		CW (cold white)	5	6	15	16	30	31

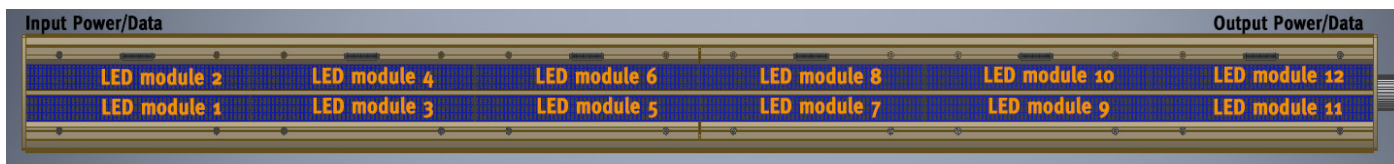

Continued on page 5.

DMX Chart 8-bit

Continued Channelmode 8-bit

The following table shows the various available modes for 8-bit control and the DMX channels required for the corresponding mode.

DMX Chart

Ch	LED module	8-bit interpolated	Ch 5	Ch 7	Ch 30	Ch 31	Ch 60	Ch 62
32	7	R (red)	1	2	16	17	31	32
33		G (green)	2	3	17	18	32	33
34		B (blue)	3	4	18	19	33	34
35		WW (warm white)	4	5	19	20	34	35
36		CW (cold white)	5	6	20	21	35	36
37	8	R (red)	1	2	16	17	36	37
38		G (green)	2	3	17	18	37	38
39		B (blue)	3	4	18	19	38	39
40		WW (warm white)	4	5	19	20	39	40
41		CW (cold white)	5	6	20	21	40	41
42	9	R (red)	1	2	21	22	41	42
43		G (green)	2	3	22	23	42	43
44		B (blue)	3	4	23	24	43	44
45		WW (warm white)	4	5	24	25	44	45
46		CW (cold white)	5	6	25	26	45	46
47	10	R (red)	1	2	21	22	46	47
48		G (green)	2	3	22	23	47	48
49		B (blue)	3	4	23	24	48	49
50		WW (warm white)	4	5	24	25	49	50
51		CW (cold white)	5	6	25	26	50	51
52	11	R (red)	1	2	26	27	51	52
53		G (green)	2	3	27	28	52	53
54		B (blue)	3	4	28	29	53	54
55		WW (warm white)	4	5	29	30	54	55
56		CW (cold white)	5	6	30	31	55	56
57	12	R (red)	1	2	26	27	56	57
58		G (green)	2	3	27	28	57	58
59		B (blue)	3	4	28	29	58	59
60		WW (warm white)	4	5	29	30	59	60
61		CW (cold white)	5	6	30	31	60	61
62		Strobe	xxx	7	xxx	xxx	xxx	62
63		Control Channel	(6)	(8)	(31)	(32)	(61)	(63)

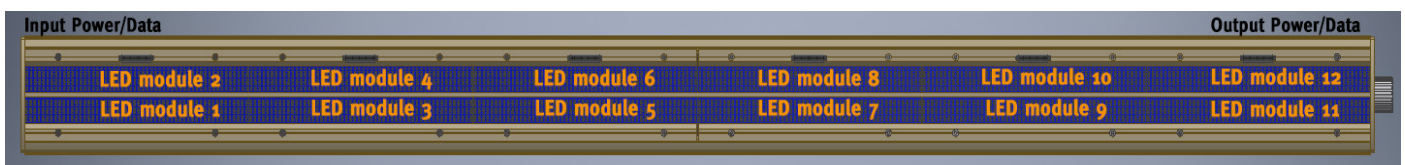

Channelmode 16-bit

The following table shows the various available modes for 16-bit control and the DMX channels required for the corresponding mode.

DMX Chart

Ch	LED module	16-bit	Ch 10	Ch 11	Ch 61	Ch 120	Ch 121
1	1	red	1	1	1	1	1
2		red fine	2	2	2	2	2
3		green	3	3	3	3	3
4		green fine	4	4	4	4	4
5		blue	5	5	5	5	5
6		blue fine	6	6	6	6	6
7		warm white	7	7	7	7	7
8		warm white fine	8	8	8	8	8
9		cold white	9	9	9	9	9
10		cold white fine	10	10	10	10	10
11	2	red	1	1	1	11	11
12		red fine	2	2	2	12	12
13		green	3	3	3	13	13
14		green fine	4	4	4	14	14
15		blue	5	5	5	15	15
16		blue fine	6	6	6	16	16
17		warm white	7	7	7	17	17
18		warm white fine	8	8	8	18	18
19		cold white	9	9	9	19	19
20		cold white fine	10	10	10	20	20
21	3	red	1	1	11	21	21
22		red fine	2	2	12	22	22
23		green	3	3	13	23	23
24		green fine	4	4	14	24	24
25		blue	5	5	15	25	25
26		blue fine	6	6	16	26	26
27		warm white	7	7	17	27	27
28		warm white fine	8	8	18	28	28
29		cold white	9	9	19	29	29
30		cold white fine	10	10	20	30	30

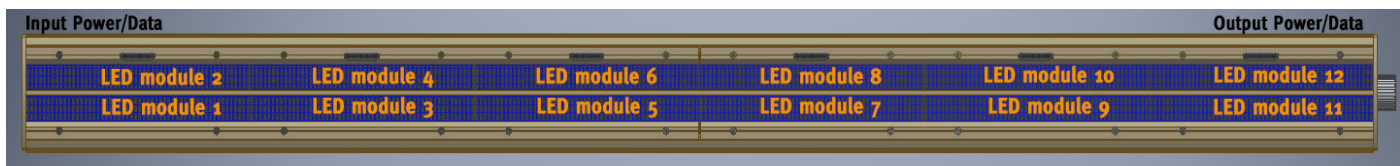

Continued on page 7.

Continued Channelmode 16-bit

The following table shows the various available modes for 16-bit control and the DMX channels required for the corresponding mode.

DMX Chart

Ch	LED module	16-bit	Ch 10	Ch 11	Ch 61	Ch 120	Ch 121
31	4	red	1	1	11	31	31
32		red fine	2	2	12	32	32
33		green	3	3	13	33	33
34		green fine	4	4	14	34	34
35		blue	5	5	15	35	35
36		blue fine	6	6	16	36	36
37		warm white	7	7	17	37	37
38		warm white fine	8	8	18	38	38
39		cold white	9	9	19	39	39
40		cold white fine	10	10	20	40	40
41	5	red	1	1	21	41	41
42		red fine	2	2	22	42	42
43		green	3	3	23	43	43
44		green fine	4	4	24	44	44
45		blue	5	5	25	45	45
46		blue fine	6	6	26	46	46
47		warm white	7	7	27	47	47
48		warm white fine	8	8	28	48	48
49		cold white	9	9	29	49	49
50		cold white fine	10	10	30	50	50
51	6	red	1	1	21	51	51
52		red fine	2	2	22	52	52
53		green	3	3	23	53	53
54		green fine	4	4	24	54	54
55		blue	5	5	25	55	55
56		blue fine	6	6	26	56	56
57		warm white	7	7	27	57	57
58		warm white fine	8	8	28	58	58
59		cold white	9	9	29	59	59
60		cold white fine	10	10	30	60	60

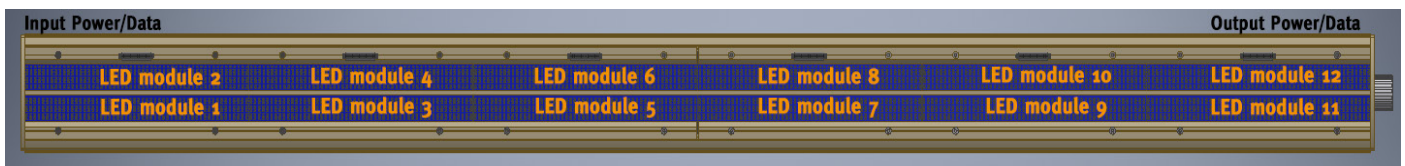

Continued on page 8.

Continued Channelmode 16-bit

The following table shows the various available modes for 16-bit control and the DMX channels required for the corresponding mode.

DMX Chart

Ch	LED module	16-bit	Ch 10	Ch 11	Ch 61	Ch 120	Ch 121
61	7	red	1	1	31	61	61
62		red fine	2	2	32	62	62
63		green	3	3	33	63	63
64		green fine	4	4	34	64	64
65		blue	5	5	35	65	65
66		blue fine	6	6	36	66	66
67		warm white	7	7	37	67	67
68		warm white fine	8	8	38	68	68
69		cold white	9	9	39	69	69
70		cold white fine	10	10	40	70	70
71	8	red	1	1	31	71	71
72		red fine	2	2	32	72	72
73		green	3	3	33	73	73
74		green fine	4	4	34	74	74
75		blue	5	5	35	75	75
76		blue fine	6	6	36	76	76
77		warm white	7	7	37	77	77
78		warm white fine	8	8	38	78	78
79		cold white	9	9	39	79	79
80		cold white fine	10	10	40	80	80
81	9	red	1	1	41	81	81
82		red fine	2	2	42	82	82
83		green	3	3	43	83	83
84		green fine	4	4	44	84	84
85		blue	5	5	45	85	85
86		blue fine	6	6	46	86	86
87		warm white	7	7	47	87	87
88		warm white fine	8	8	48	88	88
89		cold white	9	9	49	89	89
90		cold white fine	10	10	50	90	90

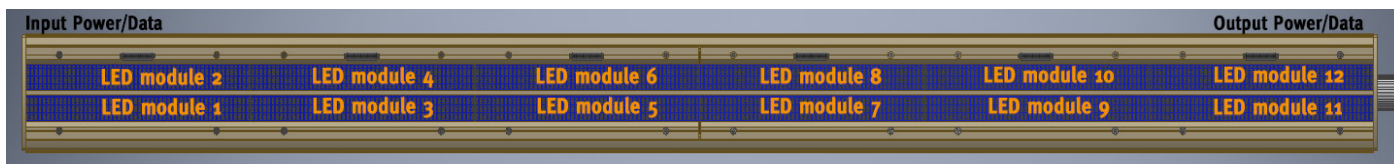

Continued on page 9.

Continued Channelmode 16-bit

The following table shows the various available modes for 16-bit control and the DMX channels required for the corresponding mode.

DMX Chart

Ch	LED module	16-bit	Ch 10	Ch 11	Ch 61	Ch 120	Ch 121
91	10	red	1	1	41	91	91
92		red fine	2	2	42	92	92
93		green	3	3	43	93	93
94		green fine	4	4	44	94	94
95		blue	5	5	45	95	95
96		blue fine	6	6	46	96	96
97		warm white	7	7	47	97	97
98		warm white fine	8	8	48	98	98
99		cold white	9	9	49	99	99
100		cold white fine	10	10	50	100	100
101	11	red	1	1	51	101	101
102		red fine	2	2	52	102	102
103		green	3	3	53	103	103
104		green fine	4	4	54	104	104
105		blue	5	5	55	105	105
106		blue fine	6	6	56	106	106
107		warm white	7	7	57	107	107
108		warm white fine	8	8	58	108	108
109		cold white	9	9	59	109	109
110		cold white fine	10	10	60	110	110
111	12	red	1	1	51	111	111
112		red fine	2	2	52	112	112
113		green	3	3	53	113	113
114		green fine	4	4	54	114	114
115		blue	5	5	55	115	115
116		blue fine	6	6	56	116	116
117		warm white	7	7	57	117	117
118		warm white fine	8	8	58	118	118
119		cold white	9	9	59	119	119
120		cold white fine	10	10	60	120	120
121		Strobe	xxx	11	61	xxx	121
122		Control Channel	(11)	(12)	(62)	(121)	(122)

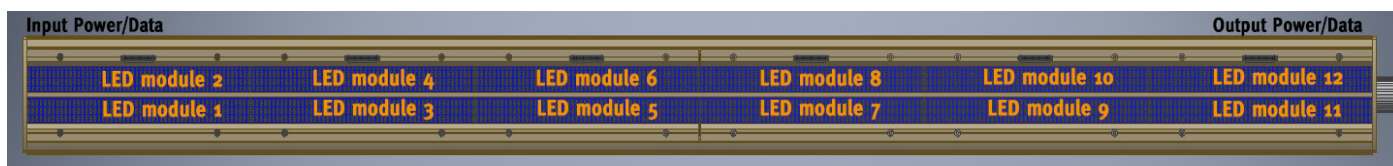

PWM Frequency

Changes to the PWM frequency can be performed here.
The possible settings can be found in the table below.

750 Hz	PWM frequency 750 Hz
1500 Hz	PWM frequency 1500 Hz
3000 Hz	PWM frequency 3000 Hz

Quiet Mode

The Quiet Mode is designed for noise-sensitive applications, for this purpose the fans can be switched on and off.
The stepless regulation of the fans is monitored with a temperature sensor.

OFF	The fans are switched on from a temperature of 40°C and controlled depending on the temperature. From a temperature of 56°C, the brightness is also adjusted.
ON	When the Quiet Mode is activated, no fan is used, the maximum brightness is limited to 70%. If the measured temperature exceeds 79°C, the fan is switched on for safety reasons in order to avoid damage to the device.

Manual Mode

In manual mode, the NanoPix2880HP can be set to any color, including strobe.
The NanoPix2880HP is then in the Ch7 - Normal Mode and the following settings can be made directly in the menu using the selection keys.

I	Intensity between DMX value 0-255
R	Red of DMX value 0-255
G	Green of DMX value 0-255
B	Blue of DMX value 0-255
WW	Warm white of DMX value 0-255
CW	Cold white of DMX value 0-255
St	Strobe of DMX value 0-255
	DMX value 0-25 no Strobe
	DMX value 26-228 - Strobe frequency from 1Hz to 25Hz
	DMX value 229-255 no Strobe

Test Mode

In this mode, the intensity is continuously scaled up and down from 0-100%, whereby the speed of the dimming process can be adjusted in 10 steps. The display shows a bar indicating the current speed.

In Test Mode three different test programs are available, see table below.
Use the Up / Down buttons to select the desired mode.
Use the Left / Right buttons to set the dimming speed.

Single	All colors are tested in sequence.
RGB	RGB is tested jointly.
RGBWWCW	All colors are tested simultaneously.

Standalone Mode

In this mode 10 fixed colors are available, which are selected with the Up / Down keys.
Use the Left / Right keys to change the brightness, which is displayed as a bar in the lower line of the display.

	R	G	B	WW	CW
Magenta	255	0	255	0	0
Lavender	255	0	255	0	255
CT Blue	0	115	255	0	255
Light Green	0	255	84	118	0
Cyan	0	255	255	0	0
Yellow	255	255	0	0	0
Light Yellow	255	255	0	255	0
Amber	255	166	0	0	0
Warm White	255	216	0	255	255
Cold White	176	255	255	255	255

Control Channel

If the control channel is activated, various functions of the NanoPix2880HP can be switched on and off via an additional DMX channel.

Control:

1. Set the Control Channel to the respective value.
2. No value change for at least 3 seconds.
3. Then flash directly to 0.
4. New setting is saved.

PWM frequency 750 Hz	11 - 20 DMX value
PWM frequency 1500 Hz	21 - 30 DMX value
PWM frequency 3000 Hz	31 - 40 DMX value
Quiet Mode ON	101 - 110 DMX value
Quiet Mode OFF	111 - 120 DMX value
Fade to Zero ON	201 - 210 DMX value
Fade to Zero OFF	211 - 220 DMX value

Fade to Zero

OFF	For a new DMX value (below DMX value 15) --> Snap to 0.
ON	For a new DMX value (below DMX value 15) is dimmed to 0.

Factory Default

Factory Default	
DMX start address	1
Channelmode	Ch7 - Normal Mode
Quiet Mode	OFF
PWM Frequency	750 Hz
Control Channel	OFF
Fade to Zero	ON
Display Rotate	OFF

Temperature

This menu displays the current temperature of the NanoPix2880HP. The value is updated every 10 seconds. When the NanoPix2880HP is switched on, „--“ is displayed in the display for 10 seconds, after which the following information appears.

<10°C	The measured temperature is below 10°C.
XX °C	The measured temperature is shown in the display.
Check Sensor	Contact an authorized LDDE dealer or contact Technical Support at service@ldde.com

Software Version

The display shows the current software version.

Display Rotate

Here you can rotate the display 180 degrees.

Tech Support

The display shows service@ldde.com.

Technical specifications

Weight / Dimensions

Length 1206 mm / 47,48 Inches
Width 120 mm / 4,72 Inches
Height 90 mm / 3,54 Inches
Weight (without accessories)..... 9,2 kg / 20,28 lb

Control

Protocol DMX512/1990
Daisy chaining max. 10 NanoPix2880HP

Dimming

Dimming Dimmer 0 - 100%
DMX-Channels 5 / 7 / 10 / 11 / 30 / 31 / 60 / 61 / 62 / 120 / 121 DMX-Channels
Configuration OLED Display

Light Source

LED Engine LED module with RGB, warm white, cold white
Average life span approx. 30.000 hrs.

Connections

Input / Output 8-pin Power/Data multicore

Electrical specifications

Input voltage range..... 100-240VAC | 50/60Hz
Max. power consumption230VA

Construction

Housing Aluminium continuous casting profile
Color black
Minimum clearance of the LED 100mm
Minimum clearance for sufficient cooling 300mm
Cooling Sensor-controlled fan system
Protection class IP20

Safety standards

Certifications EN 55015, EN 60598-1, EN 61000-3-2, EN 61000-3-3, EN 61547
Photobiological safety according to IEC 62471:2008 / EN 62471:2008

Temperatures

Maximum ambient temperature..... ta: +40°C / +104°F

Dimensions

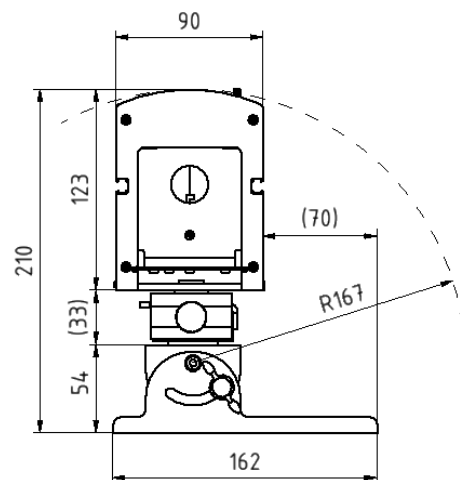
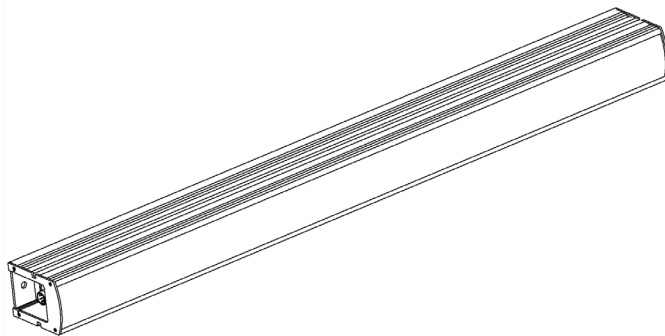
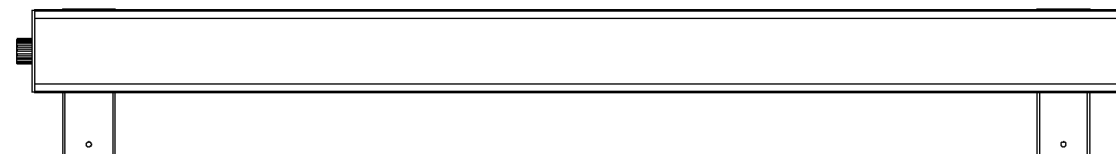
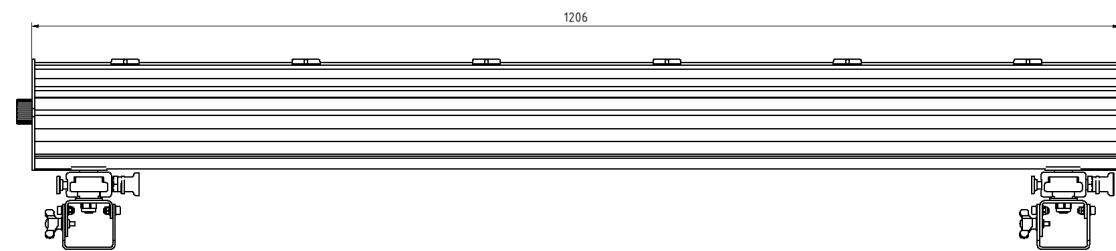
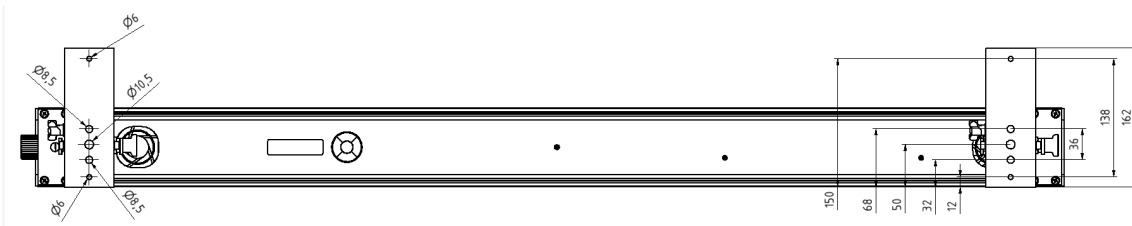



EG-Konformitätserklärung EC Declaration of Conformity



Der Hersteller:
The manufacturer:

LDDE Vertriebsgesellschaft m.b.H
Simmeringer Hauptstraße 357
AT-1110 Wien
Austria

erklären hiermit, dass das nachfolgend angeführte Produkt den einschlägigen grundlegenden Schutzanforderungen, die in den Richtlinien des Rates zur Angleichung der Rechtsvorschriften der Mitgliedsstaaten über die EMV,- und Niederspannungsrichtlinie festgelegt sind, entspricht.

declare that the product listed below complies with the relevant basic protection requirements set out in the Council Directives on the approximation of the laws of the Member States relating to the EMC, EMC and Low Voltage Directives.

EMV-Richtlinie 2004/108/EG
EMC-Directive 2004/108/EC

Produkttyp / Baureihe:
Product type / Model series:

NanoPix1440HP / NanoPix2880HP

EG Richtlinien, angewandte harmonisierte Normen:
EC Directives, applied harmonized standards:

EN 55015, EN 60598-1 EN 61000-3-2, EN 61000-3-3, EN 61547, EN 62471

Diese Erklärung wird verantwortlich für den Hersteller bzw. Inverkehrbringer.
This declaration becomes responsible for the manufacturer or distributor.

LDDE Vertriebsgesellschaft m.b.H, Simmeringer Hauptstraße 357, A-1110 WIEN, Austria

abgegeben durch

Kurt Reiter

Geschäftsführer / CEO

Wien am 27.11.2017

LDDE Vertriebsgesellschaft m.b.H. | Simmeringer Hauptstraße 357 | A 1110 Vienna | Austria
T: +43 1 7671811-0 | F: +43 1 7671811-99 | E: office@ldde.com | U: www.ldde.com
Raiffeisenbank Region Schwechat | IBAN: AT62 3282 3000 0100 5107 | BIC: RLNWATWW823
UID: ATU 36771409 | GF: Kurt Reiter | Gerichtsstand: Wien | FB-Nr.: FN 38949d

Seite 1/1